

Blood Relation Questions for SBI PO Exam

Directions (1-3): Read the following information carefully to answer the questions that follow:
A family consists of eight members J, K, L, M, E, F, G and H. K is the parent of E who is the only sister of J. H is father-in-law of K. M is the only daughter of H. G is the son of F who is son in law of H. L is father of J.

Q1. How many females are there among the given members of the family?

- (a) Two
- (b) Three
- (c) Four
- (d) More than four
- (e) Cannot be determined

Q2. How is J related to K?

- (a) Father
- (b) Father-in-law
- (c) Son
- (d) Cannot determined
- (e) Daughter

Q3. How is G related to L?

- (a) Son
- (b) Uncle
- (c) Daughter
- (d) Niece
- (e) Nephew

Directions (4-5): Study the information carefully and answer the questions given below.

J, K, L, M, N and O are six members of a family. There are equal numbers of male and female in the family. J is the son of M and N is the daughter of J. K is the child of L who is the mother of N. O is paternal grandmother of K.

Q4. How is O related to L?

- (a) Daughter-in-law
- (b) Mother-in-law
- (c) Mother
- (d) Father-in-law
- (e) Father

Q5. How is K related to M?

- (a) Daughter
- (b) Father
- (c) Son
- (d) Grandson
- (e) Granddaughter

Directions (6-9): Study the following information and answer the given questions.

There are nine members in three generations and three married couples in the family. There are only four male members in the family. Q is son of T who is daughter-in-law of P. X is father of V. R is mother of S who is father of U. S is son-in-law of W. V is unmarried and aunt of U. X is not married to R.

Q6. Who among the following is Son-in law of X?

- (a) P
- (b) S
- (c) Q
- (d) R
- (e) U

Q7. How R is related to Q?

- (a) Grandfather
- (b) Father
- (c) Sister
- (d) Grandmother
- (e) Brother

Q8. Who among the following is nephew of V?

- (a) Q
- (b) S
- (c) R
- (d) P
- (e) T

Q9. Which of the statement is false with respect to T?

- (a) T is mother of U
- (b) P is father-in-law of T
- (c) X is mother of T
- (d) T is sister of V
- (e) All are true

Q10. If there are 5 members in a family, K is mother-in-law of P. L is father of R. O is son of P. R is unmarried female. How K related to O?

- (a) Mother
- (b) Father
- (c) Aunt
- (d) Grandmother
- (e) Sister

Directions (11-12): Study the following information carefully and answer the question given below-

There are eight members in a family i.e., K, O, L, N, Q, M, P and S. Among them three are married couples. S is the daughter of the one who is L's nephew. Q is the daughter-in-law of the one who is grandfather of M. O has only one grandson. P is grand-daughter-in-law of K. L is O's husband's sister.

Q11. How many children P's father-in-law has?

- (a) Two
- (b) One
- (c) Three
- (d) Four
- (e) None of these

Q12. Who among the following is father of N?

- (a) O
- (b) L
- (c) K
- (d) M
- (e) None of these

Directions (13-15): Study the following information carefully and answer the given questions.

There are eight members in a family i.e. A, B, C, D, E, F, G and H. There are three females and two married couples. A is son-in-law of C. B is daughter in law of G who is father of H. H is unmarried. D is son of C. C married to F who is grandfather of E. E is niece of H who is brother of A.

Q13. Who among the following is brother-in-law of D?

- (a) G
- (b) C
- (c) A
- (d) B
- (e) None of these

Q14. Who among the following is brother-in-law of B?

- (a) A
- (b) H
- (c) D
- (d) G
- (e) None of these

Q15. Who among the following is father of D?

- (a) E
- (b) F
- (c) A
- (d) H
- (e) None of these

Directions (16-17): Read the following information carefully and answer the given questions.

There are eight people in a family, all of them are going for vacation. There are two married couple in the family. C is the mother of B. E is the daughter of A who is the sister of F. C is the only sister of G. H is father of C. D is the mother of C. A is the wife of G.

Q16. Who among the following is grandfather of E?

- (a) B
- (b) G
- (c) C
- (d) H
- (e) None of these

Q17. How F is related to G?

- (a) Sister-in-law
- (b) Mother
- (c) Son
- (d) Brother
- (e) Cannot be determine

Directions (18-20): Read all the information carefully and answer the given questions:

Eight persons H, J, K, L, R, O, S, P of a family going for vacation. There are four married couples and two generations in the family. S who is the brother-in-law of P is going with his wife O. H is the paternal uncle of P. L is the sister-in-law of R and going with her nephew P. J is the sister-in-law of O. The husband of R has two children. S is son-in-law of R's husband.

Q18. How is K related to J?

- (a) Daughter
- (b) Father
- (c) Mother
- (d) Daughter-in-law
- (e) None of these

Q19. How is R related to O?

- (a) Aunt
- (b) Father-in-law
- (c) Mother
- (d) Uncle
- (e) None of these

Q20. How is H related to R?

- (a) Brother
- (b) Brother-in-law
- (c) Mother-in-law
- (d) Father-in-law
- (e) None of these

Directions (21-22): Study the following information carefully and answer the questions given below.

There are eight member- A, B, C, D, E, F, G and H in a family with three generation. D is mother of G. H is niece of C. A is father of E. B has only two married sons. G is grandson of B. F is sister-in-law of C who is father of G. A is not married to F.

Q21. Who among the following is mother of H?

- (a) F
- (b) C
- (c) B
- (d) C
- (e) G

Q22. Who among the following is nephew of E?

- (a) D
- (b) F
- (c) G
- (d) H
- (e) C

Directions (23-25): Study the following information carefully and answer the given questions:

M, P, Q, R, S, T and W are seven persons of three generation living in the same house. There are two married couple in the house. M is the only daughter of P who is the paternal grandfather of T. R is the son of Q. T is the daughter of S. R is the father of W. T is sister of W.

Q23. How is M related to S?

- (a) Mother in-law
- (b) Sister in-law
- (c) Father in-law
- (d) Sister
- (e) Can't determined

Q24. How is W related to R?

- (a) Son
- (b) Father
- (c) Daughter
- (d) Can't determined
- (e) Mother

Q25. Which of the following is the pair of "husband-wife"?

- (a) P, W
- (b) T, M
- (c) M, S
- (d) Q, M
- (e) R, S

Directions (26-27): Study the following information carefully and answer the questions given below:

There are Seven Members A, B, C, D, E, F and L in a family. There are two married couples and only three generations in the family. F is grandmother of B who is niece of D. F has one son and one daughter. C is brother-in-law of D. L is grandfather of E. B has one sibling.

Q26. How is F related to mother of B?

- (a) sister
- (b) grandmother
- (c) daughter
- (d) mother
- (e) wife

Q27. How is C related to child of A?

- (a) Grandfather
- (b) father
- (c) Uncle
- (d) Brother
- (e) Cousin

Directions (28-30): Study the following information carefully and answer the questions given below:

There are seven family members P, Q, R, S, T, U and V, in which there are two married couples. P is sister of Q. Q is son of T's daughter. R is sister-in-law of V who is father of P. U is the mother of R. U is married to T.

Q28. What is the relation between Q and R?

- (a) Q is the son of R
- (b) Q is the nephew of R
- (c) R is the father of Q
- (d) Q is daughter-in-law of R
- (e) None of these

Q29. Who among the following is husband of U?

- (a) V
- (b) T
- (c) P
- (d) R
- (e) None of these

Q30. How is S related to U?

- (a) Brother
- (b) Father
- (c) Sister
- (d) Daughter
- (e) None of these

Directions (31-33): Study the information carefully and answer the questions given below.

Seven persons i.e., T, U, V, W, X, Y and Z are in three generation of the family. X is daughter in law of T who is grandfather of Z. Y is unmarried. W is Father-in-law of U. V has only one child. V is grandmother of Y who is brother-in-law of U. W has only one son. V is wife of T.

Q31. How is U related to X?

- (a) Daughter
- (b) Son-in-law
- (c) Brother
- (d) Sister-in-law
- (e) None of these

Q32. If F is sibling of X then how is Y related to F?

- (a) Brother
- (b) Daughter-in-law
- (c) Niece
- (d) Nephew
- (e) None of these

Q33. How is V related to W?

- (a) Father
- (b) Mother
- (c) Brother
- (d) Sister
- (e) Can't be determined

Directions (34-35): Study the information given below and answer the questions based on it.

Seven people A, B, C, D, E, F and G belong to the same family. B is the father of A. C is the father of D. E is the mother of F. D is the sister of F. G is the mother of C. A is the sister of C. E has only one daughter.

Q34. How is F related to G?

- (a) Son
- (b) Daughter
- (c) Grandson
- (d) Grand-daughter
- (e) Brother

Q35. How is A related to E?

- (a) Sister-in-law
- (b) Sister
- (c) Mother
- (d) Aunt
- (e) Daughter

Directions (36-38): Study the information carefully and answer the questions accordingly.

There are nine members in a family of three generations. R is the grandfather of T and married to S. U is the brother-in-law of W. Y is the niece of V who is the sibling of R. Z is the nephew of W. W and X are sibling and both are married. R has only one daughter. T and Z are cousins. V is unmarried person.

Q36. How W is related to T?

- (a) Nephew
- (b) Son
- (c) Father
- (d) Uncle
- (e) None of these

Q37. Find the odd one.

- (a) X, Z
- (b) W, S
- (c) R, U
- (d) V, Y
- (e) Y, X

Q38. Who among the following is a married couple?

- (a) X, U
- (b) Y, X
- (c) U, W
- (d) V, T
- (e) None of these

Directions (39-43): Study the following information carefully and answer the given questions.

There are nine members in three generation family i.e., J, T, U, C, M, Q, E, S, and G. Among them there are 3 married couples and only four females. J is paternal uncle of Q. U has only 2 children. S is daughter-in-law of M and M is son-in-law of T. C is married to M. E and G are sons of C. E is not married. T is father-in-law of S's father-in-law. T is married to U.

Q39. Who among the following person is father of Q?

- (a) T
- (b) U
- (c) G
- (d) S
- (e) M

Q40. How is G related to T?

- (a) Grandson
- (b) Daughter
- (c) Daughter in law
- (d) Sister
- (e) None of these

Q41. Which of the following is true about U?

- (a) U is aunt of Q
- (b) M is daughter of U
- (c) J is sister of U
- (d) S is grandson of U
- (e) None of true

Q42. How S is related to son in law of T?

- (a) Father
- (b) Daughter in law
- (c) Son
- (d) Sister-in-law
- (e) Wife

Q43. How M's sister-in-law is related to J?

- (a) Son in law
- (b) Nephew
- (c) Niece
- (d) Daughter in law
- (e) Sister-in-law

Directions (44-47): Study the following information carefully and answer the given questions.

There are nine members in a family i.e. A, B, C, D, E, P, R, Q, and S. There are four females and three married couples. A is paternal uncle of Q. R has only 2 children. S is daughter-in-law of B. C is married to B. D and E are sons of C. E is not married. P is married to R. B is son-in-law of R. P is a male member.

Q44. Who among the following is brother-in-law of Q?

- (a) E
- (b) D
- (c) P
- (d) B
- (e) None of these

Q45. Which of the following is true about P?

- (a) P is uncle of Q
- (b) B is daughter in law of P
- (c) P is sister of A
- (d) D is grandson of P
- (e) P is father of E

Q46. How E is related to son in law of R?

- (a) Sister-in-law
- (b) Daughter
- (c) Son
- (d) Daughter in law
- (e) Wife

Q47. How B's sister-in-law is related to R's brother-in-law?

- (a) Niece
- (b) Nephew
- (c) Son
- (d) Daughter
- (e) Sister

Q48. C is the wife of B. M is the son of C. A is the brother of B and father of D. E is wife of A. How is B related to D?

- (a) Sister
- (b) Cousin
- (c) Brother
- (d) Mother
- (e) Uncle

Directions (49-51): Read all the information carefully and answer the given questions:

Eight persons H, J, K, L, R, O, S, P of a family going for vacation. There are four married couples and two generations in the family. S who is the brother-in-law of P, is going with his wife O. H is the paternal uncle of P. L is the sister-in-law of R and going with her nephew P. J is the sister-in-law of O. The husband of R has two children. S is son-in-law of R's husband.

Q49. How is K related to J?

- (a) Daughter
- (b) Father
- (c) Mother
- (d) Daughter-in-law
- (e) None of these

Q50. How is R related to O?

- (a) Aunt
- (b) Father-in-law
- (c) Mother
- (d) Uncle
- (e) None of these

Q51. How is H related to R?

- (a) Brother
- (b) Brother-in-law
- (c) Mother-in-law
- (d) Father-in-law
- (e) None of these

Directions (52-53): Study the following information carefully and answer the questions given below.

There are eight members - A, B, C, D, E, F, G and H in a family with three generations. D is mother of G. H is niece of C. A is father of E. B has only two married sons. G is grandson of B. F is sister-in-law of C who is father of G. A is not married to F.

Q52. Who among the following is mother of H?

- (a) F
- (b) C
- (c) B
- (d) D
- (e) G

Q53. Who among the following is nephew of E?

- (a) D
- (b) F
- (c) G
- (d) H
- (e) C

Directions (54-56): Study the following information carefully to answer the following question:

There are eight members in the family having three generations. There are only three married couples. A is mother of D. G is son-in-law of B. H is nephew of D. C has only one son. F is granddaughter of C. E is mother of F. D is unmarried. F is a married woman.

Q54. How C is related to D?

- (a) Father
- (b) Mother
- (c) Son
- (d) Son-in-law
- (e) Brother

Q55. Who among the following is son-in-law of E?

- (a) A
- (b) C
- (c) H
- (d) G
- (e) None of these

Q56. Who among the following is niece of D?

- (a) C
- (b) E
- (c) H
- (d) F
- (e) G

Directions (57-59): Each of these questions is based on the following information:

There are eight members in a family A, B, C, D, E, F, G and H, among them only two are married couples. C is mother-in-law of E. A is grandfather of B. H is brother-in-law of E. A has only two sons. D has no son. F and A are siblings. F is the uncle of D. B and G are siblings.

Q57. Who among the following is C's brother-in-law?

- (a) F
- (b) A
- (c) B
- (d) C
- (e) None of these

Q58. How is D related to G's mother?

- (a) Wife
- (b) daughter
- (c) Son
- (d) None of these
- (e) Husband

Q59. How is B related to H?

- (a) Nephew
- (b) aunt
- (c) Niece
- (d) None of these
- (e) Son

Directions (60-61): Study the following information carefully and answer the given questions:

E, F, G, H, I and J are six family members. E and F are a married couple. I is sister of H. F is daughter-in-law of J, who is grandmother of I's brother. H is the only son of G, who is brother of E.

Q60. What is the relation of F with H?

- (a) Brother
- (b) Mother
- (c) Uncle
- (d) Aunt
- (e) None of these

Q61. How is G related to I?

- (a) Mother
- (b) Brother
- (c) Sister
- (d) Father
- (e) None of these

Directions (62-63): Read the following information carefully and answer the questions given below:

There are seven members S, T, U, V, W, X and Y in a family among them only 3 females. S is married to V. W is grandson of V who has two children. U is sister-in-law of Y who is unmarried. X is brother-in-law of S who is mother-in-law of U.

Q62. How X is related to Y?

- (a) Uncle
- (b) Brother
- (c) Mother
- (d) Sister
- (e) Grandson

Q63. Who among the following is the father of W?

- (a) U
- (b) T
- (c) X
- (d) Y
- (e) None of these

Directions (64-65): Study the following information to answer the given questions.

P is the brother of R. R has only one daughter. R is the mother of T. T is the sister of S. Q is the father of S. S is married to U. W is the son of U.

Q64. How is R related to U?

- (a) Cannot be determined
- (b) Sister-in-law
- (c) Mother
- (d) Aunt
- (e) Mother-in-law

Q65. How is S related to P?

- (a) Niece
- (b) Cannot be determined
- (c) Nephew
- (d) Son
- (e) Daughter

Q66. Pointing to a Man, Ramesh said "His only brother is the father of my daughter's father." In this case, Ramesh is male. How is the Man related to Ramesh?

- (a) Uncle
- (b) Grandfather
- (c) Father
- (d) Brother
- (e) None of these

Directions (67-69): Each of these questions is based on the following information:

There are eight members in a family A, B, C, D, E, F, G and H, among them only two are married couples. C is mother-in-law of E. A is grandfather of B. H is brother-in-law of E. A has only two sons. D has no son. F and A are siblings. F is the uncle of D. B and G are siblings.

Q67. Who among the following is C's brother-in-law?

- (a) F
- (b) A
- (c) B
- (d) C
- (e) None of these

Q68. How is D related to G's mother?

- (a) Wife
- (b) daughter
- (c) Son
- (d) None of these
- (e) Husband

Q69. How is B related to H?

- (a) Nephew
- (b) aunt
- (c) Niece
- (d) None of these
- (e) Son

Directions (70-71): Study the following information carefully and answer the given questions:

E, F, G, H, I and J are six family members. E and F are a married couple. I is sister of H. F is daughter-in-law of J, who is grandmother of I's brother. H is the only son of G, who is brother of E.

Q70. What is the relation of F with H?

- (a) Brother
- (b) Mother
- (c) Uncle
- (d) Aunt
- (e) None of these

Q71. How is G related to I?

- (a) Mother
- (b) Brother
- (c) Sister
- (d) Father
- (e) None of these

Directions (72-74): Study the information carefully and answer the questions given below.

Q is the wife of P. P is the grandfather of R. Q has only one child(son) who is married to T's child. T has only two children one son and one daughter. X is grandson of T. S is brother-in-law of son of T. U and V are children of T. W is married to the son of T. X is nephew of U and he is W's child. Only consider given persons.

Q72. If R is married to Y than how is Y related to S?

- (a) Son
- (b) Daughter
- (c) Son in law
- (d) Daughter in law
- (e) Cannot be determined

Q73. How is S related to T?

- (a) Son
- (b) Daughter
- (c) Son in law
- (d) Daughter in law
- (e) Husband

Q74. How is Q related to R?

- (a) Grandfather
- (b) Grandmother
- (c) Uncle
- (d) Aunt
- (e) Either (c) or (d)

Directions (75-76): Study the following information carefully and answer the questions accordingly.

R is the mother of C. F is the son of H. G is the brother of R. R has only one daughter. C is the sister of H. T is the father of H. H is married to E.

Q75. How is R related to E?

- (a) Sister-in-law
- (b) Sister
- (c) Mother
- (d) Mother-in-law
- (e) None of these

Q76. How is H related to R?

- (a) Brother
- (b) Son
- (c) Nephew
- (d) Niece
- (e) None of these

Directions (77-79): Read the following information carefully and answer the questions given below.

There are ten members in a family of three generations in which there are three married couples. R is the daughter-in-law of P. O who is the sibling of P is the son of Z. C is unmarried. S is the male member of the family. B is the mother of O. Z is the brother-in-law of C. D is the sibling of R. P who is the son-in-law of Q is married to A.

Q77. What is the relation of C with respect to O?

- (a) Uncle
- (b) Nephew
- (c) Niece
- (d) Aunt
- (e) Either (a) or (d)

Q78. If Q is the father of A, then what is the relation of Q with respect to P?

- (a) Father
- (b) Mother
- (c) Mother-in-law
- (d) Father-in-law
- (e) None of these

Q79. How many sons do Z has?

- (a) One
- (b) Two
- (c) Three
- (d) Cannot be determined
- (e) None

Directions (80-82): Study the information carefully and answer the questions given below.

In a family of eight members there are three married couples and five female members, G is daughter-in-law of B who has two children. D is the aunt of C, D is unmarried. F is father-in-law of H and is married to E. A is the father of D.

Q80. How is H related to E?

- (a) Son
- (b) Grand father
- (c) Son in law
- (d) Daughter
- (e) Husband

Q81. Who among the following is father of D?

- (a) A
- (b) F
- (c) E
- (d) G
- (e) B

Q82. How is D related to G?

- (a) Daughter-in-law
- (b) Sister-in-law
- (c) Sister
- (d) Nephew
- (e) Daughter

Directions (83-87): Study the following information carefully and answer the given questions. There are nine members in three generation family i.e., J, T, U, C, M, Q, E, S, and G. Among them there are 3 married couples and only four females. J is paternal uncle of Q. U has only 2 children. S is daughter-in-law of M and M is son-in-law of T. C is married to M. E and G are sons of C. E is not married. T is father-in-law of S's father-in-law. T is married to U.

Q83. Who among the following person is father of Q?

- (a) T
- (b) U
- (c) G
- (d) S
- (e) M

Q84. How is G related to T?

- (a) Grandson
- (b) Daughter
- (c) Daughter in law
- (d) Sister
- (e) None of these

Q85. Which of the following is true about U?

- (a) U is aunt of Q
- (b) M is daughter of U
- (c) J is sister of U
- (d) S is grandson of U
- (e) None of true

Q86. How S is related to son in law of T?

- (a) Father
- (b) Daughter in law
- (c) Son
- (d) Sister-in-law
- (e) Wife

Q87. How M's sister-in-law is related to J?

- (a) Son in law
- (b) Nephew
- (c) Niece
- (d) Daughter in law
- (e) Sister-in-law

Directions (88-90): Study the following information carefully and answer the questions given below:

There are seven members in a family of three generation in which there are two married couples. R is married to U. V is sister-in-law of U. U has no siblings. T is father-in-law of R. R is only son of P. S is niece of V. Q is married to S's maternal grandfather. P is a female member.

Q88. How Q is related to R?

- (a) Mother
- (b) Mother-in-law
- (c) Daughter
- (d) Daughter-in-law
- (e) None of these

Q89. How R is related to S?

- (a) Nephew
- (b) Brother
- (c) Father
- (d) Son
- (e) Can't be determined

Q90. How U's spouse is related to Q's spouse?

- (a) Mother
- (b) Mother-in-law
- (c) Daughter
- (d) Daughter-in-law
- (e) Son-in-law

Directions (91-93): Study the given relation carefully and answer the related questions:

In a family of seven people with two married couples and three generations, S is grandson of E who has three children. T is mother of C who is brother of A and H. A's nephew has two paternal aunts. R is a married woman in 2nd generation.

Q91. What is the relation of H with respect to S?

- (a) Uncle
- (b) Aunt
- (c) Mother
- (d) Father
- (e) None of these

Q92. What is the relation of A with respect to R?

- (a) Brother
- (b) Brother-in-law
- (c) Sister
- (d) Sister-in-law
- (e) Can't be determined

Q93. What is the relation of E's spouse with respect to R's spouse?

- (a) Mother
- (b) None of these
- (c) Mother-in-law
- (d) Son-in-law
- (e) Daughter-in-law

Directions (94-95): Study the following information carefully and answer the questions given below.

There are seven members K, L, M, N, O, P and Q in a family which consists of two generation. M is daughter-in-law of N who is brother of L. O is only son of K. L is uncle of P who is not married. O is the brother-in-law of Q.

Q94. How P is related to M?

- (a) Sister
- (b) Aunt
- (c) Sister-in-law
- (d) Brother-in-law
- (e) Can't be determined

Q95. How many female members are there in the family?

- (a) Two
- (b) Three
- (c) Four
- (d) None of these
- (e) Can't be determined

Directions (96-97): Study the following information carefully and answer the questions given below.

There are six members A, B, C, D, E and F in the family of three generations. There is no single parent in the family. B is mother-in-law of D. A is father of C. F is brother-in-law of E. F is the maternal uncle of A.

Q96. Who is the husband of B?

- (a) E
- (b) A
- (c) None of these
- (d) C
- (e) F

Q97. How is D related to C?

- (a) Sister
- (b) Mother
- (c) Father
- (d) Brother
- (e) Sister-in-law

Directions (98-100): Study the following information carefully and answer the questions given below.

Eight persons P, Q, R, T, U, V, W and X belong to a family of three generations. There are three married couple. T is mother of R who is a male. U is father of X. U has only two children. T's mother-in-law is married to U. X is married to brother-in-law of P. V is father of W who is a female. P has a sibling.

Q98. How U is related to R?

- (a) Brother
- (b) Uncle
- (c) Father
- (d) Grandfather
- (e) None of the above

Q99. Who is the mother-in-law of V?

- (a) Q
- (b) T
- (c) X
- (d) W
- (e) None of the above

Q100. How P is related to W?

- (a) Maternal Uncle
- (b) Paternal Uncle
- (c) Brother
- (d) Nephew
- (e) None of the above

Solutions

Solutions (1-3):

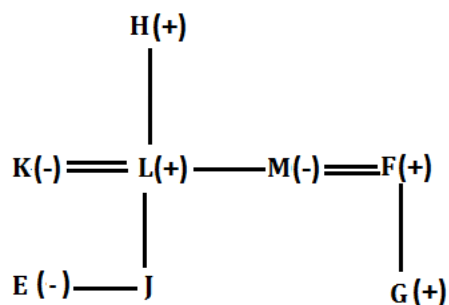

S1. Ans.(e)

S2. Ans.(d)

S3. Ans.(e)

Solutions (4-5):

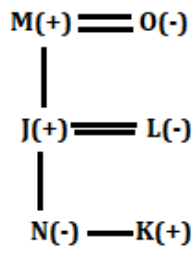

S4. Ans.(b)

S5. Ans.(d)

Solutions (6-9):

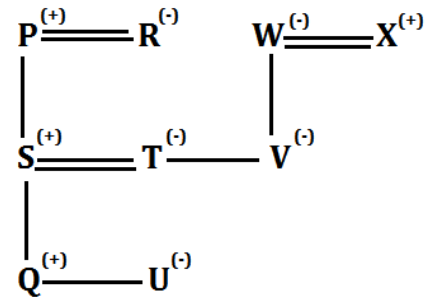

S6. Ans.(b)

S7. Ans.(d)

S8. Ans.(a)

S9. Ans.(c)

S10. Ans.(d)

Sol.

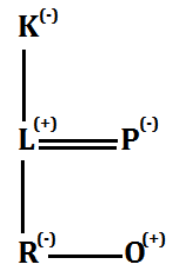

Solutions (11-12):

Sol.

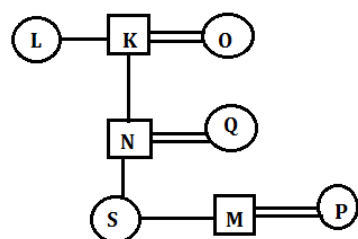

S11. Ans.(a)

S12. Ans.(c)

Solutions (13-15):

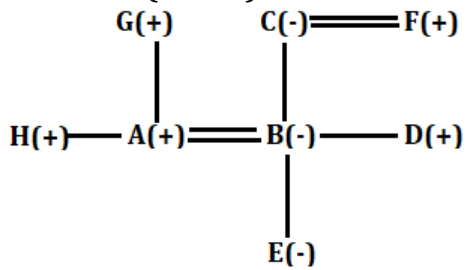

S13. Ans.(c)

S14. Ans.(b)

S15. Ans.(b)

Solutions (16-17):

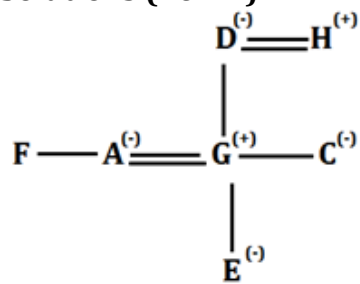

S16. Ans.(d)

S17. Ans.(e)

Solutions (18-20):

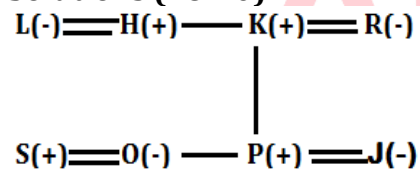

S18. Ans.(e)

S19. Ans.(c)

S20. Ans.(b)

Solutions (21-22):

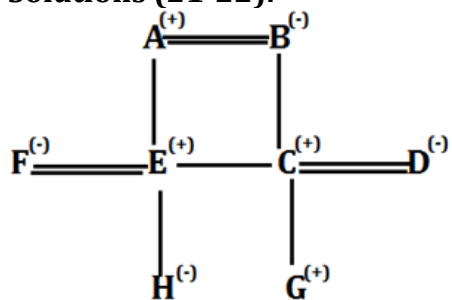

S21. Ans.(a)

S22. Ans.(c)

Solutions (23-25):

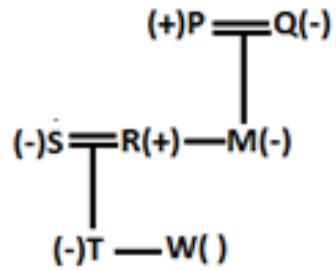

S23. Ans.(b)

S24. Ans.(d)

S25. Ans.(e)

Solutions (26-27):

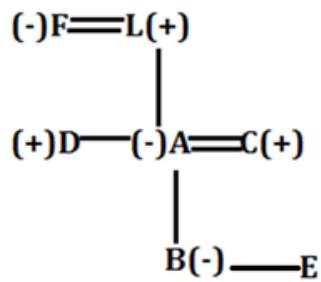

S26. Ans.(d)

S27. Ans.(b)

Solutions (28-30):

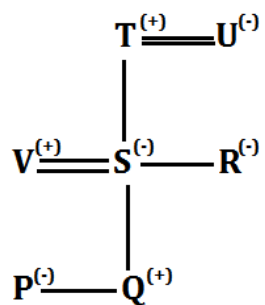

S28. Ans.(b)

S29. Ans.(b)

S30. Ans.(d)

Solutions (31-33):

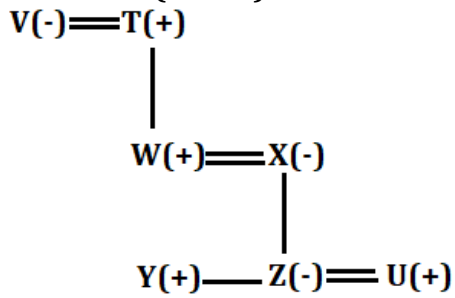

S31. Ans.(b)

S32. Ans.(d)

S33. Ans.(b)

Solutions (34-35):

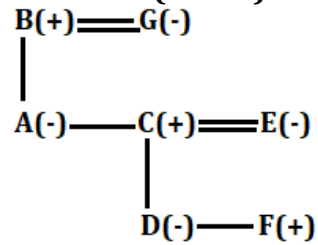

S34. Ans.(c)

S35. Ans.(a)

Solutions (36-38):

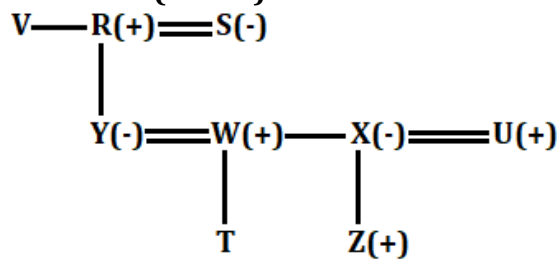

S36. Ans.(c)

S37. Ans.(d)

S38. Ans.(a)

Solutions (39-43):

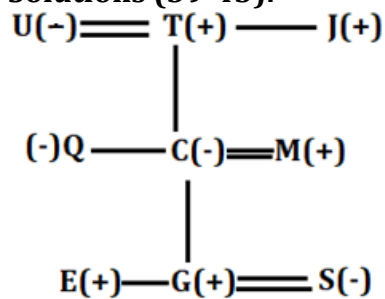

S39. Ans.(a)

S40. Ans.(a)

S41. Ans.(e)

S42. Ans.(b)

S43. Ans.(c)

Solutions (44-47):

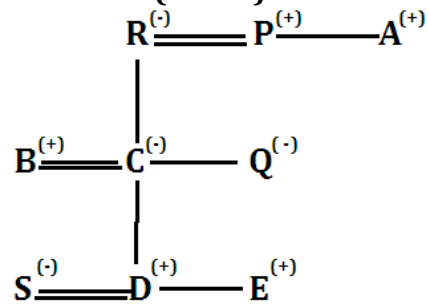

S44. Ans.(d)

S45. Ans.(d)

S46. Ans.(c)

S47. Ans.(a)

S48. Ans.(e)

Sol.

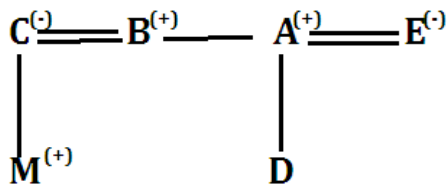

Solutions (49-51):

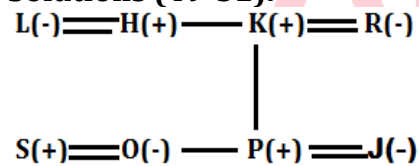

S49. Ans.(e)

S50. Ans.(c)

S51. Ans.(b)

Solutions (52-53):

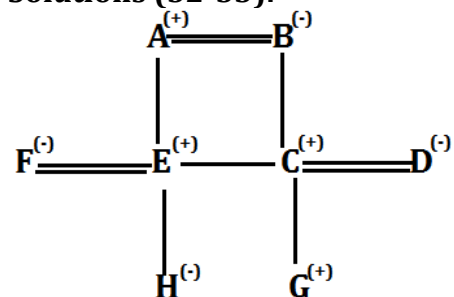

S52. Ans.(a)

S53. Ans.(c)

Solutions (54-56):

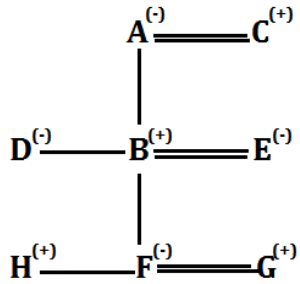

S54. Ans.(a)

S55. Ans.(d)

S56. Ans.(d)

Solutions (57-59):

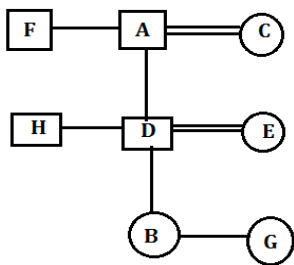

S57. Ans.(a)

S58. Ans.(e)

S59. Ans.(c)

Solutions (60-61):

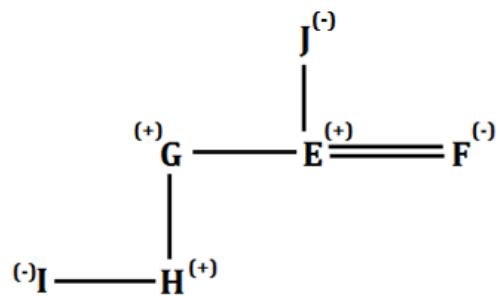

S60. Ans.(d)

S61. Ans.(d)

Solutions (62-63):

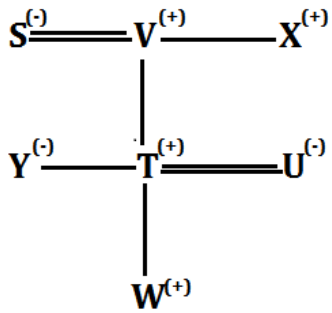

S62. Ans.(a)

S63. Ans.(b)

Solutions (64-65):

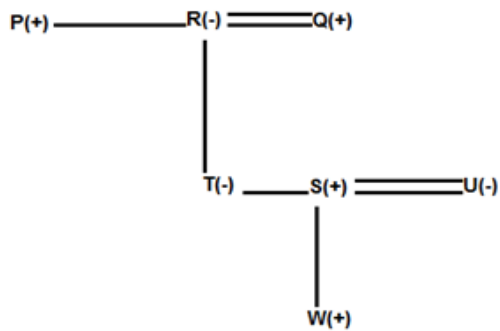

S64. Ans.(e)

S65. Ans.(c)

S66. Ans.(a)

Sol.

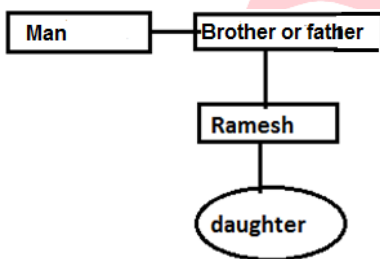

Solutions (67-69):

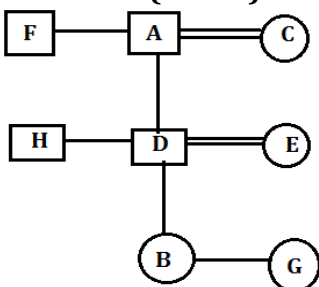

S67. Ans.(a)

S68. Ans.(e)

S69. Ans.(c)

Solutions (70-71):

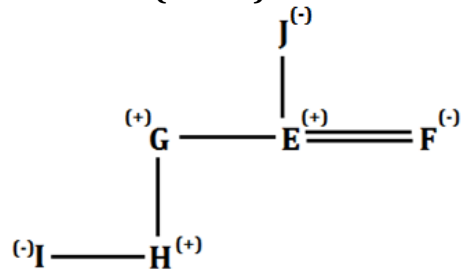

S70. Ans.(d)

S71. Ans.(d)

Solutions (72-74):

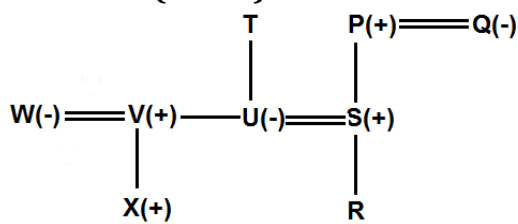

S72. Ans.(e)

S73. Ans.(c)

S74. Ans.(b)

Solutions (75-76):

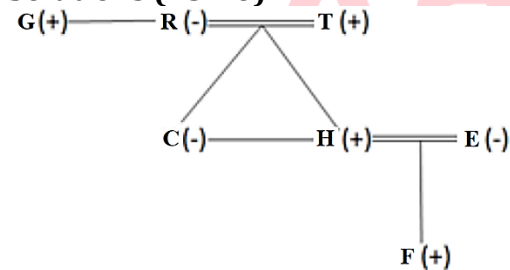

S75. Ans.(d)

S76. Ans.(b)

Solutions (77-79):

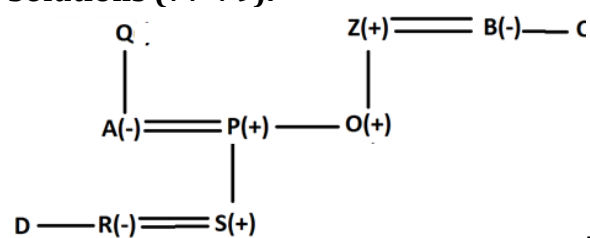

S77. Ans.(e)

S78. Ans.(d)

S79. Ans.(b)

Solutions (80-82):

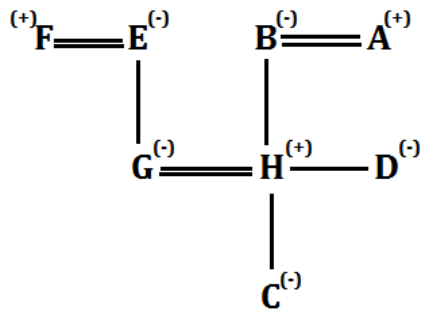

S80. Ans.(c)

S81. Ans.(a)

S82. Ans.(b)

Solutions (83-87):

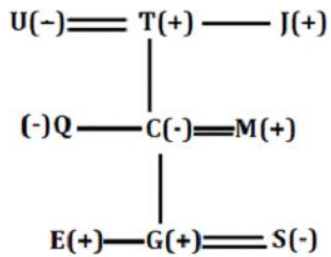

S83. Ans.(a)

S84. Ans.(a)

S85. Ans.(e)

S86. Ans.(b)

S87. Ans.(c)

S88. Ans.(b)

Sol.

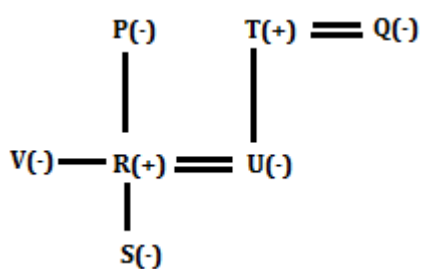

S89. Ans.(c)

Sol.

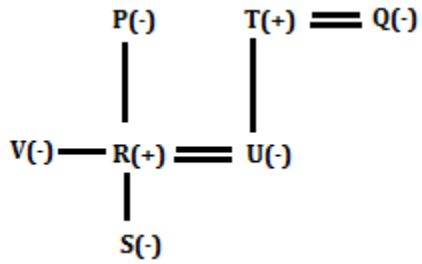

S90. Ans.(e)

Sol.

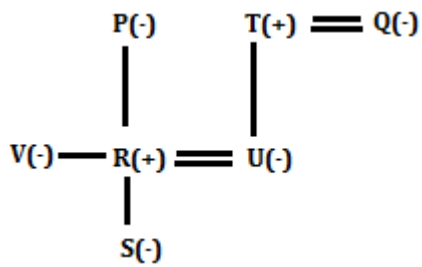

S91. Ans.(b)

Sol.

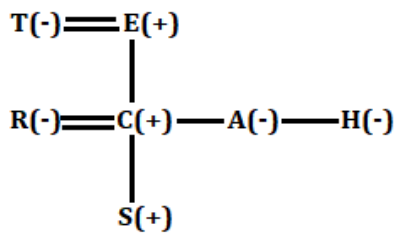

S92. Ans.(d)

Sol.

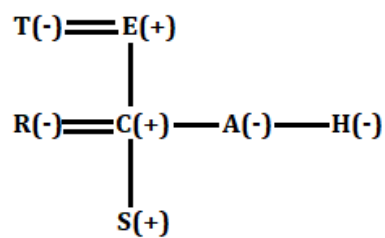

S93. Ans.(a)

Sol.

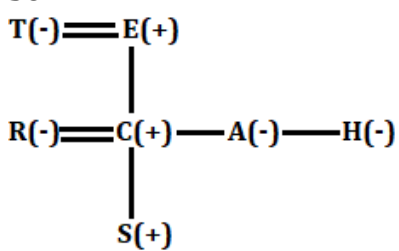

S94. Ans.(c)

Sol.

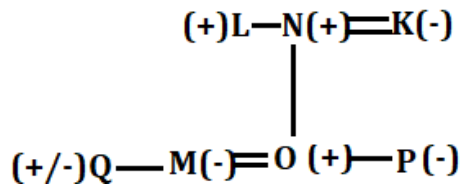

S95. Ans.(e)

Sol.

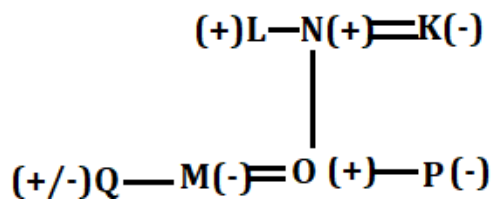

S96. Ans.(a)

Sol.

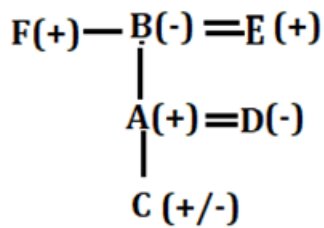

S97. Ans.(b)

Sol.

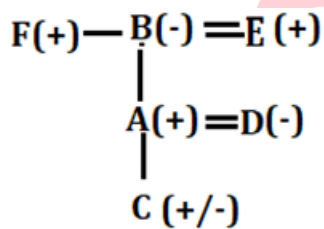

S98. Ans.(d)

Sol.

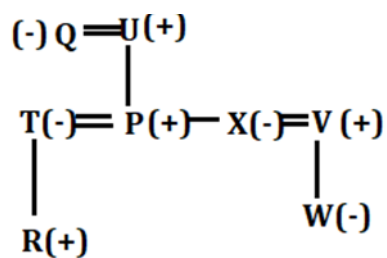

S99. Ans.(a)

Sol.

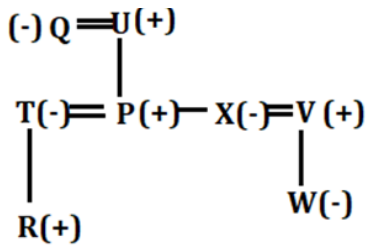

S100. Ans.(a)

Sol.

