

**Reasoning Ability Practice Questions For RBI Grade B 2023**

**Directions (1-5): Study the following information to answer the given questions.**

In a certain code language,

'Beast of Lion mafia' is written as

'ga lfo nui su'

'Horn red beast burn on', is written as

'epi zo lfo ye na'

'Mafia red spiritual energy' is written as

'zo ra nui da'

'Spiritual fire of burn' is written as

'da ga nic epi'.

**Q1.** What is the code for 'on'?

- (a) ye
- (b) na
- (c) zo
- (d) Either na or zo
- (e) Either ye or na

**Q2.** What does 'su' stand for?

- (a) mafia
- (b) beast
- (c) of
- (d) Lion
- (e) None of these

**Q3.** What is the code for 'energy beast fire'?

- (a) nic ye nui
- (b) lfo ra nic
- (c) ra ga lfo
- (d) da ra nic
- (e) None of these

**Q4.** Which of the following does 'epi nui na' stand for?

- (a) burn of beast
- (b) horn beast burn
- (c) mafia burn horn
- (d) mafia burn on
- (e) Either (c) or (d)

**Q5.** Which of the following may represent 'bright side of beast'?

- (a) ga zo nui da
- (b) ga ba lfo nee
- (c) ga ba nic epi
- (d) lfo ba nui ra
- (e) None of these

**Q6.** If 'A \$ B' means 'A is the son of B', 'A @ B' means 'A is the mother of B', 'A % B' means 'A is son-in law of B' and 'A # B' means 'A is the daughter of B' then in 'P \$ R # M % N' how is N related to R?

- (a) Daughter
- (b) Grandfather
- (c) Grandmother
- (d) Can't determined
- (e) None of these

**Q7.** Pointing towards a girl in a Photograph Riya, who is a female said, "she is the only daughter of the son of my mother's father's only sister. How is Riya related to that girl?"

- (a) Paternal Aunt
- (b) Daughter
- (c) Cousin
- (d) Maternal Aunt
- (e) None of these

**Directions (8-9): Read the following information carefully and answer the given questions.**

There are eight people namely M, N, Q, T, W, X, Y and Z in a family, all of them are going to attend a marriage party. There are two married couple in the family. Q is the mother of N. W is the daughter of M who is the sister of X. Q is the only sister of Y. Z is father of Q. T is the maternal grandmother of N. M is the wife of Y.

**Q8.** How is N related to Z?

- (a) Son
- (b) Grand daughter
- (c) Grand son
- (d) Daughter
- (e) Can't determined



**BILINGUAL**

**GA Capsule**

**RBI GRADE B 2023**

**Comprehensive Current Affairs**

Start Jun 23, 2023

**Q9.** How many male members are there in the family?

- (a) Four
- (b) Three
- (c) Can't determined
- (d) Two
- (e) None of these

**Q10.** Amit is the son of Shiv. Shiv's sister, Jaya has a son Rohit and a daughter Yami. Riya is the mother of Amit's father Shiv. How is Yami related to Riya?

- (a) Mother
- (b) Granddaughter
- (c) Sister
- (d) Niece
- (e) None of these

**Directions (11-15):** Each of the questions below consists of a question and two statements numbered I and II given below it. You have to decide whether the data provided in the statements are sufficient to answer the question.

- (a) If statement I alone is sufficient to answer the question, but statement II alone is not sufficient to answer the question.
- (b) If statement II alone is sufficient to answer the question, but statement I alone is not sufficient to answer the question.
- (c) If statement either I or II is sufficient to answer the question.
- (d) If both the statements I and II taken together are not sufficient to answer the questions.
- (e) If both the statements I and II taken together are sufficient to answer the questions.

**Q11.** What is Sonali's position from the left end of a row?

- I. There are 4 students between Gauri and Sonali. Bhavna is 6th to the right of Gauri.
- II. Gini is 6th to the left of Sonali and is 2nd from the left end.

**Q12.** How many students are sitting between P and Q?

- I. P is 5th to the right of R and 6th to the left of S. Q is 6th to the right of R.
- II. In a row of 25 students, P is 5th from left end and Q is 20th from the right end.

**Q13.** Among G, H, I, J and K who among the following got third highest marks?

- I. G has got 1 mark less than H and has got more marks than K.
- II. I and J have got more marks than G.

**Q14.** How is N related to Q?

- I. C is daughter of Q who is also the mother of D.
- II. B is brother of C and N is the wife of D.

**Q15.** Who has got highest marks among A, B, C, D and E?

- I. D has got greater marks than A but less than C. B has got greater marks than A but less than E.
- II. E has got less marks than C but greater than B and D. A has got the lowest marks.

**Directions (16-20):** Study the information carefully and answer the questions given below.

Six persons P, Q, R, S, T and U are going on holiday on six different days of week (week starts from Monday to Saturday). All information is not necessarily in same order.

Not more than one person goes between Q and T who goes on Thursday. Two persons go between T and U. More than one person goes between Q and P. There is as many persons between U and R as many between R and P. Q does not go on Saturday.

**Q16.** How many persons go between Q and P?

- (a) One
- (b) Three
- (c) Two
- (d) Four
- (e) None

**Q17.** Who among the following person goes just before P?

- (a) T
- (b) R
- (c) Q
- (d) S
- (e) None of these

**Q18.** Who among the following person goes on Tuesday?

- (a) U
- (b) P
- (c) Q
- (d) R
- (e) None of these

**Q19.** How many persons goes before U?

- (a) Two
- (b) One
- (c) Four
- (d) Five
- (e) None

**Q20.** Which of the following combination is true?

- (a) Monday-Q
- (b) Tuesday-R
- (c) Tuesday-U
- (d) Friday-P
- (e) None is true

**Directions (21-25):** Study the following information carefully and answer the questions given below.

Some people are sitting in two parallel rows facing each other. A, B, C, D, E, F and G are sitting in row 1 facing north and P, Q, R, S, T, U and V are sitting in row 2 facing south (not necessarily in the same order).

Three persons sit between B and C and one of them sits at an end. Q sits fourth to the right of T. P sits to the immediate left of U who sits at the middle of the row. A is not a neighbor of B. E sits to the immediate right of the one who faces P. D faces the one who sits second to the left of V. S faces G. R faces the one who sits to the immediate right of A. T does not sit at any end.

**Q21.** Who among the following sits second to the left of the one who is facing T?

- (a) F
- (b) E
- (c) C
- (d) A
- (e) None of these

**Q22.** How many persons sit between C and the one who faces P?

- (a) None
- (b) One
- (c) Two
- (d) Three
- (e) More than three

**Q23.** Who among the following faces the person who sits diagonally opposite to S?

- (a) None of these
- (b) C
- (c) V
- (d) Q
- (e) T

**Q24.** Who among the following pair sits at the extreme end of the row?

- (a) G, B
- (b) B, S
- (c) V, C
- (d) S, E
- (e) B, D

**Q25.** What is the position of P with respect to Q?

- (a) Third to the left
- (b) Third to the right
- (c) Second to the left
- (d) Immediate right
- (e) Immediate left

**Directions (26-30):** Study the information carefully and answer the questions given below.

In a certain code language,

'Black Brown White Pink' is written as 'kl nw te ip',

'White Red Yellow Orange' is written as 'ip er ol gn',

'Orange Brown Magenta Pink' is written as 'gn nw ng te'

'Grey Black Orange Green' is written as 'yg kl sr gn'.

**Q26.** What may be the code for 'Grey magenta' in the given code language?

- (a) nw ip
- (b) er sr
- (c) sr ip
- (d) yg ng
- (e) None of these

**Q27.** What is the code for 'White' in the given code language?

- (a) ip
- (b) nw
- (c) kl
- (d) er
- (e) None of these

**Q28.** What is the code for 'Brown' in the given code language?

- (a) nw
- (b) ip
- (c) te
- (d) ng
- (e) Can't be determined

**Q29.** What is the word for 'gn' in the given code language?

- (a) Pink
- (b) Blue
- (c) Orange
- (d) Green
- (e) None of these

**Q30.** What may be the code for 'Red Orange Green'?

- (a) nw yg ip
- (b) ol gn kl
- (c) gn ip ol
- (d) er gn sr
- (e) yg gn ip

**Directions (31-35):** Study the information carefully and answer the questions given below.

Aman starts his journey from point K, walks 8m towards South to reach at point Z, then takes a right turn and walks for 6m to reach point M. From point M he takes a left turn and walks for 9m to reach at point G, from point G he takes a left turn and walks 14m to reach at point L, then takes a left turn again and walks 17m to reach point I. From point I, He walks 4m in west direction and reached point P.

**Q31.** What is the shortest distance between point P and K?

- (a) 6m
- (b) 8m
- (c) 4m
- (d) 10m
- (e) None of these

**Q32.** What is the total distance covered by Aman from point K to point P?

- (a) 59m
- (b) 58m
- (c) 56m
- (d) 54m
- (e) 57m

**Q33.** In which direction is point M with respect of point L?

- (a) North-east
- (b) South
- (c) South-west
- (d) East
- (e) North-west

**Q34.** What is the shortest distance between point K and M?

- (a) 10m
- (b) 20m
- (c) 11m
- (d) 12m
- (e) None of these

**Q35.** In which direction is point Z with respect of point I?

- (a) North
- (b) South
- (c) North-west
- (d) South-east
- (e) None of these

**Directions (36-40):** Answer the questions based on the information given below.

In a certain language,

"These pilots need slow" is coded as

"D%14 E&20 W%19 S#16"

"Ego spoils every work" is coded as

"K%23 S#19 O@5 Y&5"

"All train were moving" is coded as

"L@1 G#13 N&20 E%23"

"That boy moves slowly" is coded as

"S&13 Y@2 T%20 Y#19"

**Q36.** What is the code for the word "Dare"?

- (a) E%4
- (b) S%1
- (c) K@1
- (d) S@4
- (e) None of the above

**Q37.** What is the code for the word "Frauds"?

- (a) K@12
- (b) S#6
- (c) K@6
- (d) D#12
- (e) None of the above

**Q38.** What is the code for the word "Hired"?

- (a) E%8
- (b) Y%1
- (c) D&8
- (d) E&15
- (e) None of the above

**Q39.** What is the code for the word "Fee"?

- (a) E@20
- (b) E&6
- (c) T@6
- (d) E@6
- (e) None of the above

**Q40.** What is the code for the word "Offer"?

- (a) R%15
- (b) R&14
- (c) R&15
- (d) R#15
- (e) None of the above

**Directions (41-45): Study the following information carefully and answer the given questions.**

In a certain code language,  
 'Water earth fixing food' is coded as 'zq ie mn as'  
 'Award no earth fixing' is coded as 'mn bn st ie'  
 'Award word fixing food' is coded as 'cd as mn bn'  
 'Water food coaching glass' is coded as 'zq as zx yx'

**Q41.** Which of the following is the code for 'no'?

- (a) st
- (b) bn
- (c) ie
- (d) mn
- (e) None of these

**Q42.** Which of the following word is coded as 'bn'?

- (a) Word
- (b) Food
- (c) No
- (d) Award
- (e) None of these

**Q43.** What may be the code of 'word orange'?

- (a) st ie
- (b) cd mn
- (c) ie bn
- (d) mn ie
- (e) cd qw

**Q44.** Which of the following code is coded for 'Earth'?

- (a) mn
- (b) ie
- (c) bn
- (d) cd
- (e) None of these

**Q45.** What will be the code of 'glass'?

- (a) zx
- (b) as
- (c) yx
- (d) Either (a) or (c)
- (e) None of these

**Directions (46-50): Study the following information carefully and answer the given questions.**

Seven scientist A, B, C, D, E, F and G belongs to different country viz, Japan, France, Russia, Australia, China, India and Germany but not necessarily in the same order. They are living in a seven-floor building where lowermost floor is numbered as 1 and topmost floor is numbered as 7.

D lives on fourth floor but does not belong to China. F belongs to Japan and he lives either on sixth or on third floor. C lives on first floor. E belongs to Germany. B does not live on seventh floor. The one who belongs to Australia lives on second floor. F does not live immediate below G. A lives on fifth floor and he belongs to India. The one who belongs to France lives on Seventh floor.

**Q46.** Who among the following lives immediate below F?

- (a) The one who belongs to China
- (b) G
- (c) D
- (d) The one who belongs to Australia
- (e) C

**Q47.** How many persons live in between G and the one who belongs to Russia?

- (a) Four
- (b) One
- (c) Two
- (d) Three
- (e) None

**Q48.** Who among the following lives exactly between A and C?

- (a) F
- (b) G
- (c) D
- (d) B
- (e) E

**Q49.** How many persons live below the one who belong to Germany?

- (a) None
- (b) Two
- (c) Three
- (d) More than three
- (e) One

**Q50.** Who among the following belongs to France?

- (a) E
- (b) G
- (c) B
- (d) C
- (e) D



**Directions (51-53):** Study the following information carefully to answer the given questions.

Eight Persons P, Q, R, S, T, U, W and X in a family. There are three married couple. T is sister of P. R is grandfather of X. W is father of U. Q is daughter in law of S who is married to R. X is unmarried male and has no sibling. T is married to U who has no child.

**Q51.** Who among the following is nephew of T?

- (a) R
- (b) X
- (c) S
- (d) Q
- (e) None of these

**Q52.** Who among the following is son-in-law of S?

- (a) P
- (b) X
- (c) R
- (d) U
- (e) None of these

**Q53.** What is the relation of Q with X?

- (a) Mother
- (b) Aunt
- (c) Grand-Mother
- (d) Sister
- (e) Wife

**Directions (54-56):** Study the following information and answer the questions given below:

- 'Q + R' means 'Q is father of R'
- 'Q ÷ R' means 'R is brother of Q'
- 'Q × R' means 'Q is husband of R'
- 'Q - R' means 'Q is sister of R'

**Q54.** In the expression 'B + D - S + C ÷ A', how is A related to B?

- (a) Son
- (b) Daughter
- (c) Grandson
- (d) Can't be determined
- (e) None of these

**Q55.** Which of the following expressions shows that 'Z is sister of X'?

- (a)  $J + Z - L + N \div X$
- (b)  $J - N - L \div X \times Z$
- (c)  $J \times L - Z \div X + N$
- (d)  $J - Z - L + N \div X$
- (e) None of these

**Q56.** Which of the following is true for the given expression: 'P - J + K - L + N ÷ M'?

- (a) P is aunt of N's father
- (b) K is father of M
- (c) N is sister of M
- (d) J is father of N
- (e) None of these

**Q57.** Pointing to a photograph of a girl Rohit says, "She is the only daughter of my father." How is Rohit related to the girl?

- (a) Son
- (b) Brother
- (c) Father
- (d) Uncle
- (e) Nephew

**Q58.** Shivani says pointing towards a Girl, "She is the daughter of the wife of my brother". In this relation, Shivani is a female then how Shivani is related to the girl?

- (a) Aunt
- (b) Niece
- (c) CND
- (d) Cousin
- (e) Sister

**Directions (59-60):** Study the following information carefully and answer the questions which follow:

- 'M + K' means 'M is brother of K'
- 'M ÷ K' means 'M is father of K'
- 'M × K' means 'M is wife of K'
- 'M - K' means 'M is sister of K'
- 'M = K' means 'M is mother of K'

**Q59.** In expression 'P × A ÷ M - Z = F', how is F related to P?

- (a) Grandchild
- (b) Grandson
- (c) Grand daughter
- (d) Grandmother
- (e) Son

**Q60.** Which of the following expression represents the relationship 'D is daughter - in - law of C'?

- (a)  $D \times H + N = E \div C$
- (b)  $H + D \times N \div E = C$
- (c)  $C = F + L - Z \times D$
- (d)  $C \times F \div L \div Z \times D$
- (e) None of these

**Directions (61-65):** In each of the questions below, some statements are given followed by some Conclusions. You have to take the given statements to be true even, if they seem to be at variance from commonly known facts. Read all the conclusions and then decide which of the given conclusions logically follows from the given statements disregarding commonly known facts.

- (a) If both conclusions I and II follow
- (b) If either conclusion I or II follows
- (c) If neither conclusion I nor II follows
- (d) If only conclusion II follows
- (e) If only conclusion I follows

**Q61. Statements:** Some wire are blue  
Only a few blue is road  
All road are green

**Conclusion:** I: All blue can be green  
II: Some road are wire

**Q62. Statements:** All text are camera  
Some camera are lens  
No lens is red

**Conclusion:** I: All text can never be red  
II: Some camera are not red

**Q63. Statements:** Some copy are paste  
Only paste is cut  
Some paste is page

**Conclusions:** I. No copy is page  
II. Some copy is page

**Q64. Statements:** All knife are sharp  
All sharp are pencil  
Some sharp are pen

**Conclusions:** I. No pencil are pen  
II. Some pen are pencil

**Q65. Statements:** No star are shine  
Some shine are light  
No stone is shine

**Conclusions:** I: Some light are not star  
II: All stone can never be light

**Directions (66-68):** Read the following information carefully to answer the following questions-

- (i) 'M @ N' means M is brother of N.
- (ii) 'M \$ N' means M is mother of N.
- (iii) 'M & N' means M is father of N.
- (iv) 'M %N' means M is wife of N.
- (v) 'M #N' means M is son of N.

**Q66.** If the expression 'A%B#D&F@G' is true, then who among the following is sister-in-law of G?

- (a) F
- (b) D
- (c) B
- (d) A
- (e) None of these

**Q67.** If the expression 'H\$K#M@N%O' is true, then how N is related to K?

- (a) Mother
- (b) Father
- (c) Aunt
- (d) Uncle
- (e) None of these

**Q68.** If the expression 'D&C#G\$K%L@R' is true, then who among the following is father-in-law of L?

- (a) D
- (b) K
- (c) G
- (d) C
- (e) None of these

**Q69.** Introducing a man, a woman says, "He is the son-in-law of the wife of my father and I am the only child of my parents". How is the man related to the woman?

- (a) Nephew
- (b) Husband
- (c) Brother-in-law
- (d) Cousin
- (e) CND

**Q70.** If 'A + B' means 'A is father of B', 'A ÷ B' means 'A is mother of B', 'A × B' means 'A is husband of B', 'A - B' means 'A is sister of B', then in the given expression how R is related to M - 'M+N×O÷T-R'

- (a) Grandfather
- (b) Grandson
- (c) Granddaughter
- (d) Son
- (e) Cannot be determined

**Directions (71-75):** Study the following information to answer the given questions

In a certain code

'Crown rub book pen' is written as 'op lp we jkl',

'Room rub book fan' is written as 'ir lp fu op'.

'Pen bottle room wire' is written as 'ty ir gb jkl'

'Book light bottle bulb' is written as 'ty xz lo lp'

**Q71.** What is the code of 'Rub'?

- (a) we
- (b) op
- (c) jkl
- (d) lp
- (e) None of these

**Q72.** Which of the following word is coded as 'ty'?

- (a) Wire
- (b) Bulb
- (c) Book
- (d) Light
- (e) Bottle

**Q73.** What is the code of 'room'?

- (a) fu
- (b) op
- (c) ir
- (d) gb
- (e) None of these

**Q74.** What is the code of 'fan wire'?

- (a) fu gb
- (b) op jkl
- (c) ir ty
- (d) gb we
- (e) None of these

**Q75.** Which word is coded as 'we'?

- (a) Book
- (b) Crown
- (c) Fan
- (d) Wire
- (e) None of these

**Directions (76-79):** Study the information carefully and answer the questions given below.

Point B is 10m north of point A. Point C is 24m south of point D which is 5m east of point E. Point G is 5m west of point F. Point C is 15m east of point B. Point F is 12m south of point E.

**Q76.** What is the shortest distance between point G and point B?

- (a) 14m
- (b) 11m
- (c) 13m
- (d) 10m
- (e) 5m

**Q77.** What is the direction of point E with respect of point G?

- (a) South-west
- (b) North-east
- (c) South
- (d) North
- (e) North-west

**Q78.** If point H is 8m north of point C, what is the direction and distance of Point H with respect to point B?

- (a) 12m, North-East
- (b) 7m, North
- (c) 15m, South-west
- (d) 17m, North-East
- (e) 10m, North-west

**Q79.** What is the direction of point A with respect to point F?

- (a) South- East
- (b) North- West
- (c) South-West
- (d) North
- (e) South

**Q80.** If A@B means 'B is west of A', A#B means 'A is south of B', A%B means 'A is east of B' and A&B means 'A is north of B'. Then what is the direction of P with respect of R in the given expression - P % Q # S @ R

- (a) North
- (b) South
- (c) North- East
- (d) South- West
- (e) South- East

**Directions (81-85):** Answer the following question based on the information given below.

Seven persons are sitting around a heptagonal table such that one person is sitting at each corner facing inward. Each of them has scored different marks in a recent test. The marks scored by them were in ascending order clockwise, starting from V. No two persons scored the same marks or consecutive numbers as marks. The passing marks in the test was 33.

Q scored 61 and is sitting second to the left of G. S scored 18 marks less than G. V is an immediate neighbour of N. The difference between the marks scored by E and N was 10. The immediate neighbour of V scored 34 marks. B scored 7 more marks than V. The sum of the marks scored by V and the one sitting to the immediate left of G was 85. V failed by 4 marks.

**Q81.** Who is sitting third to the left of S?

- (a) Q
- (b) The one who scored 59 marks
- (c) The one who scored 67 marks
- (d) The one who scored 56 marks
- (e) None of these

**Q82.** Who scored higher than E?

- (a) B
- (b) The one who scored 52 marks
- (c) N
- (d) S
- (e) None of these

**Q83.** The sum of the marks scored by E and \_\_\_\_ is 92.

- (a) V
- (b) B
- (c) N
- (d) S
- (e) None of these



**Q84.** How many persons are sitting in between the person who scored the lowest odd marks but passed the test and G, counted to the right of G?

- (a) One
- (b) Two
- (c) Three
- (d) More than three
- (e) None of these

**Q85.** Four of the following five are alike in a certain way and hence form a group as per the given arrangement. Which of the following does not belong to that group?

- (a) N - 29
- (b) B - 52
- (c) G - 56
- (d) Q - 66
- (e) S - 34

**Directions (86-90):** Study the following information carefully and answer the questions given below.

**Input:** 39 55 13 20 37 41 68 53

Step I: 13 39 55 37 41 68 53 20

Step II: 13 37 55 41 68 53 20 39

Step III: 13 37 41 68 53 20 39 55

Step IV: 13 37 41 53 20 39 55 68

Step V: 15 34 43 50 22 36 57 65

Step VI: 15 34 43 50 36 57 65 22

Step VII: 15 43 50 36 57 65 22 34

Step VIII: 15 43 57 50 65 22 34 36

Step IX: 15 43 57 65 22 34 36 50

And Step IX is the last step of the rearrangement. As per the above arrangement, find the steps for the given input.

**Input:** 25 58 47 33 23 73 64 61

**Q86.** How many steps are needed to complete this arrangement?

- (a) X
- (b) XI
- (c) VI
- (d) VIII
- (e) IX

**Q87.** Which of the following is fourth from the left end of Step VI in the above arrangement?

- (a) 61
- (b) 30
- (c) 60
- (d) 63
- (e) None of these

**Q88.** Which of the following represents the sum of the first and the last elements in the second last step?

- (a) 50
- (b) 85
- (c) 100
- (d) 95
- (e) 115

**Q89.** Which of the following is step V of the given input?

- (a) 25 27 61 63 70 30 44 62
- (b) 25 44 63 70 27 30 62 61
- (c) 25 44 63 70 27 30 60 61
- (d) 25 44 63 70 27 60 61 30
- (e) None of these

**Q90.** Which elements are in between 6th from the left and 6th from the right in step IV?

- (a) 63, 70
- (b) 44, 59
- (c) 73, 25
- (d) 21, 62
- (e) 64, 73

**Directions (91-95):** Answer the questions based on the information given below.

In a code language,

"Provision science finger" is coded as "4DD, 4JQ, 5SM"

"Software hardwork (1) language" is coded as "5PD, 4BD, 6FQ, 6BJ"

"Original munch bouncing" is coded as "5PF, 4VG, 4SK"

"Documents conditioner creature design" is coded as "4FM, 6PR, (2), 6PQ"

**Q91.** What will come in the place of (1)?

- (a) September
- (b) Single
- (c) October
- (d) Roaster
- (e) None of these

**Q92.** What is the code for the word 'Principal' in the given language?

- (a) 6SK
- (b) 5TN
- (c) 6SR
- (d) 5RK
- (e) None of these

**Q93.** What will come in the place of (2)?

- (a) 6RC
- (b) 5SE
- (c) 4RM
- (d) 4SD
- (e) None of these

**Q94.** What is the code for the word 'Celebrate Enterprise' in the given language?

- (a) 5GD, 6PE
- (b) 6FD, 5OD
- (c) 5FD, 6OD
- (d) 5ED, 6OE
- (e) None of these

**Q95.** What is the code for the word 'Sparkling' in the given language?

- (a) 7QF
- (b) 7FQ
- (c) 8QF
- (d) 8FQ
- (e) None of these

**Directions (96-100): Study the following information carefully and answer the questions given below:**

In a certain code language:

'Member song mail' is written as 'yt po ki',  
'Boat complete dope' is written as 'tu at uj',  
'Mail dope Boat' is written as 'at yt uj'  
'Member mail Boat' is written as 'yt uj ki'.

**Q96.** What is the code for 'song member' in the given code language?

- (a) tu uj
- (b) po ki
- (c) at uj
- (d) uj po
- (e) None of these

**Q97.** What is the code for 'complete' in the given code language?

- (a) tu
- (b) ki
- (c) at
- (d) uj
- (e) None of these

**Q98.** What is the code for 'Boat' in the given code language?

- (a) tu
- (b) po
- (c) at
- (d) uj
- (e) None of these

**Q99.** What may be the code for 'mail delivered'?

- (a) yt sa
- (b) po ki
- (c) at sa
- (d) sa tu
- (e) None of these

**Q100.** What is the code for 'mail dope' in the given code language?

- (a) yt fa
- (b) yt at
- (c) uj ki
- (d) yt uj
- (e) None of these

**Directions (101-105): Study the information carefully and answer the questions given below.**

Eight persons are sitting in two rows such that each row consists of four persons facing each other. Persons of row 1 face north and persons of row 2 face south. They also like different colors. Only one person sits between E and C. H faces the one who likes yellow. A does not like purple and sits in same row as F. B does not face E and G. G and D, are immediate neighbors of each other. The one who likes black sits diagonally opposite to the one who likes purple. F does not like pink. The one who likes blue sits at one of the left ends. E likes maroon. The one who likes purple does not face south. H is immediate neighbor of the one who faces F. G does not like pink or green. F faces the one who likes black color. The one who likes green sits immediate right to the one who faces the one who likes white.

**Q101.** Who among the following likes blue?

- (a) D
- (b) F
- (c) C
- (d) B
- (e) None of these

**Q102.** Which color is liked by the one who sits 2<sup>nd</sup> left to H?

- (a) Maroon
- (b) White
- (c) Blue
- (d) Black
- (e) None of these

**Q103.** Who among the following likes green color?

- (a) D
- (b) F
- (c) C
- (d) B
- (e) None of these

**Q104.** Who among the following faces the one who sits immediate right to the one who likes yellow color?

- (a) E
- (b) F
- (c) C
- (d) B
- (e) None of these

**Q105.** According to the sitting arrangement if C is related to A, H is related to G, then B is related to?

- (a) E
- (b) A
- (c) F
- (d) D
- (e) None

**Directions (106-108):** Read the information carefully and answer the question:

Point D is 7m south of Point C which is 5m east of point B. Point F is 12m west of point G. Point E is 6m east of point D and Point A is 10m north of point B. Point E is 17m south of point F and Point H 12m north of point E.

**Q106.** What is the shortest distance between point H and point G?

- (a) 10m
- (b) None of these
- (c) 16m
- (d) 13m
- (e) 7m

**Q107.** What is the direction of point E with respect to point A?

- (a) South
- (b) South-East
- (c) South- West
- (d) North-West
- (e) North

**Q108.** If point P is 5m west of point D, then what is the distance and direction of point P with respect to A?

- (a) 17m, South
- (b) 12m, South-West
- (c) 10m, North
- (d) 15m, West
- (e) 11m, North-east

**Directions (109-110):** Study the following information carefully and answer the given questions:

Point P is 12m east of point Q. Point Q is 9m north of point R and also 11m south of point S. Point T is 8m west of point S. Point R is 14m south of point U. Point W is 15m west of point R.

**Q109.** Point W is in which direction with respect to point S?

- (a) North-west
- (b) South-west
- (c) North-east
- (d) South-east
- (e) None of these

**Q110.** What is the shortest distance between U and P?

- (a)  $\sqrt{29}$ m
- (b) 13m
- (c)  $\sqrt{37}$ m
- (d) 6m
- (e) None of these

**Directions (111-115):** Study the given information carefully and answer the questions that follow:

Eight friends A, B, C, D, E, F, G and H sits around a circular table in such a way that four of them face opposite to the center while rest face towards the center.

G and C face same direction but opposite to D and B. D sits third to the left of H who sits third to the right of B. G sits third to the right of F. A sits opposite to D. E sits opposite to C who is not an immediate neighbor of B. F doesn't face outside. A faces towards the center. Not more than two persons sit together facing same direction.

**Q111.** How many people sit between H and D when counted from the right of H?

- (a) None
- (b) Four
- (c) One
- (d) Three
- (e) Two

**Q112.** Which of the following is true regarding A?

- (a) Both F and E are immediate neighbors of A
- (b) Only three people sit between A and G
- (c) A faces same as E
- (d) F sits second to the right of A
- (e) None of the given options is true

**Q113.** What is the position of C with respect to G?

- (a) Second to the left
- (b) Third to the left
- (c) Second to the right
- (d) Fifth to the right
- (e) Fifth to the left

**Q114.** Four of the following five are alike in a certain way and so form a group. What is the one who does not belong to that group?

- (a) B
- (b) C
- (c) H
- (d) E
- (e) G

**Q115.** Who sits second to the left of F?

- (a) E
- (b) B
- (c) D
- (d) A
- (e) None of these

**Directions (116-120):** In each of the questions below, some statements are given followed by conclusions numbered I and II. You have to assume all the statements to be true even if they seem to be at variance from the commonly known facts and then decide which of the given two conclusions logically follows from the information given in the statements.

- (a) If only conclusion I follows
- (b) If only conclusion II follows
- (c) If either conclusion I or II follows
- (d) If neither conclusion I nor II follows
- (e) If both conclusion I and II follow

**Q116. Statements:** All Noun are Article

No Article is Verb  
Some verb is Tense

**Conclusions:** I. Some Tense is Noun is a possibility  
II. Some Noun is Verb

**Q117. Statements:** No Water are Bubble

All Bubble is Clear  
Only Clear are Rain

**Conclusions:** I. No Rain is Water  
II. Some Clear is water

**Q118. Statements:** Some Video are Audio

All Picture are Audio  
No Study is picture

**Conclusions:** I. Some Video are Picture is a possibility  
II. No Audios is Study

**Q119. Statements:** Only a few Green are Purple

All Purple are Black  
No Green is Blue

**Conclusions:** I. Some Purple is Blue  
II. All Green is Black is a possibility

**Q120. Statements:** Some Line are Square

Some Square are Circle  
No Square are Graph

**Conclusions:** I. Some Line is Graph  
II. Some Circle is line

**Directions (121-125):** In these questions, relationship between different elements is shown in the statements. These statements are followed by two conclusions:

- (a) if only conclusion I follows.
- (b) if only conclusion II follows.
- (c) if either conclusion I or II follows.
- (d) if neither conclusion I nor II follows.
- (e) if both conclusion I and II follow.

**Q121. Statements:**  $N=P, P \leq F, F \geq L, L=K$

**Conclusions:** I.  $F=K$                       II.  $F > K$

**Q122. Statements:**  $Z > T < M < J$

**Conclusions:** I.  $T < J$                       II.  $J < Z$

**Q123. Statements:**  $Q=Z, C \geq G, G \geq Q, Q \geq R, J \geq C$

**Conclusions:** I.  $G \geq Z$                       II.  $C \geq R$

**Q124. Statements:**  $A > B > C < D > E > F$

**Conclusions:** I.  $E > C$                       II.  $F > B$

**Q125. Statements:**  $K < L, K > M, M \geq N, N > O$

**Conclusions:** I.  $O < M$                       II.  $O < K$

**Directions (126-127):** Study the information carefully and answer the questions given below.

P is father of M who is brother-in-law of K. N is daughter in law of Z who is grandmother of L. P has only two children one son and one daughter. X is sister-in-law of N. P is father-in-law of N. K is unmarried.

**Q126.** If K is wife of J, then what could be the relation of J with respect to N?

- (a) Brother
- (b) Brother-in-law
- (c) Uncle
- (d) Cannot be determined
- (e) None of these.

**Q127.** What is relation of L with respect to X?

- (a) Nephew
- (b) Niece
- (c) Son
- (d) Daughter
- (e) Cannot be determined

**Directions (128-130):** Study the following information carefully to answer the questions given below:

P, Q, R, S, U, V and T are the members of a family. There are three generation in this family. P is mother-in-law of T. V is sister of S who is nephew of R. U is granddaughter of Q. T is a married woman. R is not sibling of P.

**Q128.** Who among the following is niece of V?

- (a) U
- (b) Q
- (c) R
- (d) T
- (e) None of these

**Q129.** How is R related to V?

- (a) Niece
- (b) Father
- (c) Aunt
- (d) Uncle
- (e) Cannot be determine

**Q130.** Who among the following is mother of U?

- (a) V
- (b) R
- (c) P
- (d) T
- (e) None of these

**Directions (131-135):** Study the information carefully and answer the questions given below.

Eight persons A, B, C, D, E, F, G and H are going for a holiday in four different months i.e., January, March, April and May on two different dates i.e., 11<sup>th</sup> and 22<sup>nd</sup>. All information is not necessarily in same order.

D goes in the month which has even number of days. Two persons go between D and F. E goes just after H but not in the same month. C goes after B. A goes before G. Not more than one person goes between C and A. C does not goes in the month which has even number of days. G does not go in March. Not more than one person goes between A and G.

**Q131.** Who among the following person go on 11<sup>th</sup> January?

- (a) A
- (b) C
- (c) G
- (d) D
- (e) None of these

**Q132.** On which of the following date A goes on holiday?

- (a) 11<sup>th</sup> April
- (b) 22<sup>nd</sup> March
- (c) 11<sup>th</sup> May
- (d) 22<sup>nd</sup> April
- (e) 11<sup>th</sup> March

**Q133.** How many persons goes between F and H?

- (a) One
- (b) Three
- (c) Four
- (d) More than Four
- (e) None

**Q134.** Who among the following goes just after D?

- (a) C
- (b) H
- (c) A
- (d) G
- (e) None of these

**Q135.** Four of the following five are alike in certain way thus from a group, find the one who does not belong to that group?

- (a) B
- (b) D
- (c) E
- (d) G
- (e) A

**Directions (136-140):** Read the given information carefully and answer the questions given below:

Twelve Persons are sitting in two parallel rows -A, B, C, D, E and F are sitting in row 1 facing in south and I, G, K, L, M and N are sitting in row 2 facing in north. Therefore, in the given seating arrangement each member seated in a row faces another member of the other row.

L sits third to the left of I. F does not face I. Neither L nor I sit at an extreme end. G sits at one of the extreme ends. Only two people sit between G and M. F is not an immediate neighbor of E. M does not face F. Two persons sit between B and C. F does not sit at any of the extreme ends. E faces L. C is not an immediate neighbor of E. A does not face I. K sits left of N.

**Q136.** Who among the following sits diagonally opposite to C?

- (a) G
- (b) F
- (c) K
- (d) I
- (e) None of these

**Q137.** Who among the following sits third to the left of E?

- (a) D
- (b) F
- (c) A
- (d) C
- (e) None of these

**Q138.** Who among the following faces M?

- (a) A
- (b) F
- (c) C
- (d) B
- (e) E

**Q139.** Four of the following five form a group, which among the following does not belong to this group?

- (a) G, F
- (b) N, E
- (c) M, A
- (d) I, B
- (e) L, A

**Q140.** How many persons sit between N and K?

- (a) Three
- (b) Two
- (c) None
- (d) One
- (e) More than Three

**Q141.** A person starts walking towards point Y which is in North direction of starting point. From point Y, he starts walking in west direction then he takes a right turn to reach at point W. From point W, he takes a right turn and stop at point J. Find in which direction the person is facing now?

- (a) North
- (b) South
- (c) East
- (d) West
- (e) None of these

**Q142.** Point H is 5m west of J. Point J is 10m south of point T. Point T is 12m west of G. Point G is 6m north of Point D. Point D is 15m east of Point Y. What is the shortest distance between Point J and Point Y?

- (a) 10m
- (b) 4m
- (c) 9m
- (d) 7m
- (e) None of these

**Directions (143-145):** Study the information carefully and answer the questions given below.

Point A is 12m west of point B. Point F is 8m east of point D. Point G is 10m north of point E. Point C is 8m south of point B. Point D is 3m north of point C. Point E is 6m west of point C.

**Q143.** What is the shortest distance between point D and point A?

- (a) 13m
- (b) 10m
- (c) 12m
- (d) 14m
- (e) None of these

**Q144.** Point D is in which direction with respect to point G?

- (a) North-East
- (b) South-west
- (c) East
- (d) North
- (e) South-east

**Q145.** If Point Y is 7m south of point G, then what is the shortest distance between Point Y and Point F?

- (a) 16m
- (b) 14m
- (c) 13m
- (d) 10m
- (e) None of these

**Directions (146-150):** Study the following information carefully and answer the given questions.

In a certain code language,

‘Logitech and the Logo’ is coded as ‘yi pq mn as’

‘Registered Trademark and the’ is coded as ‘mn bn st pq’

‘Registered Corporate the Logo’ is coded as ‘cd as mn bn’

**Q146.** Which of the following is the code for ‘and’?

- (a) st
- (b) bn
- (c) pq
- (d) mn
- (e) None of these

**Q147.** Which of the following word is coded as ‘mn’?

- (a) Corporate
- (b) Logo
- (c) Trademark
- (d) Registered
- (e) None of these

**Q148.** What may be the code of 'Corporate society'?

- (a) st pq
- (b) cd mn
- (c) pq bn
- (d) mn pq
- (e) cd qw

**Q149.** Which of the following code is coded for 'logitech'?

- (a) mn
- (b) pq
- (c) bn
- (d) cd
- (e) None of these

**Q150.** What will be the code of 'the Logo'?

- (a) st pq
- (b) cd as
- (c) cd pq
- (d) mn as
- (e) st bn

**Directions (151-155): Consider the alphanumeric string given below consisting of letters, numbers and symbols and answer the questions that follow based on the given steps: -**

**© M K 1 & N Y 6 C = 4 W Ω B T U 2 3 A R E 0 β  
G + S X 5 @ B 0 8 V ^ % H L 9**

**Step I:** Each such symbol that is immediately preceded by a number and immediately succeeded by a letter should be placed to the left of '3' (1st symbol picked from the left should be placed to the immediate left of 3, then 2<sup>nd</sup> symbol should be placed to the immediate left of 1<sup>st</sup> symbol and so on).

**Step II:** Each such number that is immediately preceded and immediately succeeded by letters should be placed to the immediate right of 'X' in descending order from left to right in the new series formed after step I.

**Step III:** Each such letter that is immediately preceded by a letter and immediately succeeded by a number should be placed to the immediate left of + in reverse alphabetical order from left to right in the new series formed after step II.

**Q151.** If all the symbols are dropped from the step III, then which will be the 12<sup>th</sup> element from the right end?

- (a) L
- (b) S
- (c) 8
- (d) U
- (e) R

**Q152.** If the last eighteen elements of step III are rearranged in reverse order, then which of the following will be the 10<sup>th</sup> element to the left of '1' after the rearrangement?

- (a) 9
- (b) G
- (c) E
- (d) X
- (e) None of these

**Q153.** If all the numbers are arranged in ascending order within the same position of numbers in the step III, then which of the following element is 20<sup>th</sup> to the left of '5' after the rearrangement?

- (a) Ω
- (b) W
- (c) B
- (d) 0
- (e) None of these

**Q154.** How many elements are between W and X in step II?

- (a) 14
- (b) 15
- (c) 16
- (d) 18
- (e) None of these

**Q155.** What is the sum of all odd numbers which are right of A in step I?

- (a) 14
- (b) 10
- (c) 6
- (d) 8
- (e) None of these



**Directions (156-158): Study the following information and answer the questions given below:**

There is a figure provided in the question given below which consist of a square composed of four triangles. Some operations are performed to convert the input figure into the output figure.

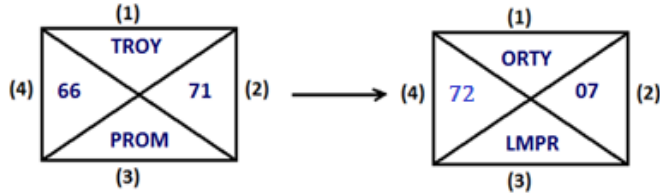

**For Words** - If addition of the place value of all the letters of the word is divisible by 6, then the letters of the word is arranged in the English alphabetical order, but if the addition of the place value of all the letters of the word is not divisible by 6, then the letters of the word arranged in the alphabetical order after changing the vowel by its opposite letter in the English alphabet.

**For Numeric**- If addition of the given two-digit number is divisible by both 2 and 3, then number is changed by the addition of the square of each digit, but if the addition of the digits of the given two-digit number is not divisible by both 2 and 3 then the number is changed by their multiplication.

Based on the above example, find the output figure of the following input.

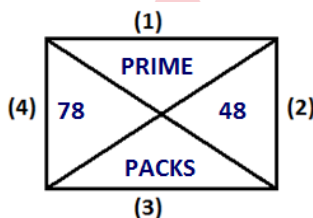

**Q156.** Which of the following number represents the element of triangle 4 of the output figure?

- (a) 38
- (b) 56
- (c) 36
- (d) 54
- (e) None of these

**Q157.** What is the difference between the digits of the triangle 2 and triangle 4 of the output figure?

- (a) 100
- (b) 26
- (c) 93
- (d) 24
- (e) None of these

**Q158.** Which of the following letter represents the element of triangle 3 of the output figure?

- (a) CPPSZ
- (b) CKLSZ
- (c) CKPSZ
- (d) CKPHZ
- (e) None of these

**Q159.** If all the vowels of the word 'SCRABBLE' are replaced by its succeeding letter according to the English alphabet and all the consonant are replaced with their previous letter according to the English alphabet and then all the letters are arranged in the alphabetical order from left to right then how many letters are there between the third letter from the left and second letter from the right in the English alphabetic series?

- (a) 11
- (b) 13
- (c) 14
- (d) 15
- (e) None of these

**Q160.** How many such pairs of letters are in the word 'INSTALLATION', each of which has as many letters between them as in the English alphabet (both forward and backward directions)?

- (a) None
- (b) Two
- (c) Four
- (d) Three
- (e) More than four

**Directions (161-163): Study the following information carefully and answer the questions given below:**

There are six poles in a ground. All poles are of different height. Pole T is taller than pole U. Pole Q is taller than pole S but shorter pole R. Pole Q is not the 2<sup>nd</sup> shortest Pole. Pole P is taller than pole U and pole Q which is shorter than pole T. The third shortest pole is 40m. Pole R is not the tallest. Pole U is taller than pole S. Height of tallest pole is 80m. Height of pole T is a prime number. Pole T is not taller than pole R.

**Q161.** Which of the following pole is tallest?

- (a) U
- (b) Q
- (c) P
- (d) T
- (e) None of these



**Q162.** Which of the following may be the height of pole T?

- (a) 63m
- (b) 31m
- (c) 55m
- (d) 67m
- (e) None of these

**Q163.** Which of the following pole is second shortest?

- (a) T
- (b) U
- (c) S
- (d) R
- (e) None of these

**Directions (164-166): Study the following information carefully and answer the questions given below:**

In a certain code language:

'States and gates pictures' is written as 'xl sa zh hx',

'News standard in upgrade' is written as 'ha fa dx da',

'Pictures upgrade and News' is written as 'sa dx xl da'

'States pictures in News' is written as 'xl fa hx da'.

**Q164.** What is the code for 'pictures upgrade' in the given code language?

- (a) xl fa
- (b) xl dx
- (c) da fa
- (d) dx da
- (e) None of these

**Q165.** What is the code for 'standard' in the given code language?

- (a) ha
- (b) fa
- (c) dx
- (d) da
- (e) None of these

**Q166.** What is the code for 'upgrade' in the given code language?

- (a) ha
- (b) fa
- (c) dx
- (d) da
- (e) None of these

**Q167.** If in the number "56298761", all digits are arranged in increasing order from left to right then how many digits remains at the same place in the new arrangement?

- (a) Three
- (b) Four
- (c) None
- (d) Two
- (e) One

**Q168.** How many pairs of letters are there in the word "GOVERNMENT", each of which have as many letters between them as they have between them in the English alphabetical series?

- (a) Three
- (b) One
- (c) Two
- (d) More than three
- (e) None

**Q169.** Kamal ranked 28th from the top and 17th from the bottom in a class. How many students are there in the class?

- (a) 40
- (b) 38
- (c) 45
- (d) 43
- (e) 44

**Q170.** If in the number "56289174", 2 is subtracted from each of the digits which is greater than and equal to 6 and 2 is added to each of the digit which is less than 6, then how many digits are repeating in the number thus formed?

- (a) Two
- (b) One
- (c) None
- (d) Three
- (e) Four

**Directions (171-175): Study the following information carefully and answer the question given below-**

In a family, there are eight members i.e., R, E, X, B, Y, J, P and O who are sitting around a circular table and facing opposite to centre. There are three generation in which two married couple and only two female members are there.

B is maternal grandfather of O and sits immediate right of X. The daughter of B sits opposite to B. R is son-in law of P who is mother of J. E is brother of R who is father of O. E is paternal uncle of X who is grandson of P. The brother of Y is J who is unmarried. J is maternal Uncle of O and sits immediate left of Y. Y is mother of X and B has only two children. R is an immediate neighbor of Y. P does not sit adjacent to her any grandson. E sits 2<sup>nd</sup> right of B and he is unmarried.

**Q171.** Who is the father of X?

- (a) O
- (b) B
- (c) R
- (d) J
- (e) E

**Q172.** Who among the following sits 2<sup>nd</sup> left of Y's mother?

- (a) X
- (b) B
- (c) R
- (d) J
- (e) E

**Q173.** Who among the following sits opposite to O?

- (a) P
- (b) B
- (c) R
- (d) J
- (e) E

**Q174.** How many members sit between R and E when counted from the left to R?

- (a) One
- (b) Two
- (c) Three
- (d) Four
- (e) None

**Q175.** Who among the following is father of J?

- (a) O
- (b) X
- (c) E
- (d) R
- (e) B

**Directions (176-180):** Study the following information carefully and answer the given questions. In a certain code language,

'Shape plastic around lost' is coded as 'mx fe fm pz'

'Plastic Feature heavy around' is coded as 'fm pz xe kx'

'Shape around smog Feature' is coded as 'xi xe fm fe'

'Export lost around phone' is coded as 'hb mx yz fm'

**Q176.** Which of the following is the code for 'around'?

- (a) mx
- (b) xe
- (c) fe
- (d) fm
- (e) None of these

**Q177.** Which of the following word is coded as 'pz'?

- (a) Smog
- (b) Shape
- (c) Plastic
- (d) Around
- (e) None of these

**Q178.** What may be the code of 'word Shape'?

- (a) fe fm
- (b) fe kx
- (c) fe xi
- (d) fe zx
- (e) fe pz

**Q179.** Which of the following code is coded for 'Feature'?

- (a) fe
- (b) xe
- (c) pz
- (d) xi
- (e) None of these

**Q180.** What will be the code of 'export'?

- (a) hb
- (b) xi
- (c) yz
- (d) Either (a) or (c)
- (e) None of these

**Directions (181-185):** In each of the questions below, some statements are given followed by some Conclusions. You have to take the given statements to be true even, if they seem to be at variance from commonly known facts. Read all the conclusions and then decide which of the given conclusions logically follows from the given statements disregarding commonly known facts.

- (a) If only conclusion I follows.
- (b) If only conclusion II follows.
- (c) If either conclusion I or II follows.
- (d) If neither conclusion I nor II follows.
- (e) If both conclusions I and II follow.

**Q181. Statements:** Some Moon are Sun  
Some Sun are Helium  
No Helium is Cheap

**Conclusions:** I: All Cheap are Sun  
II: Some Sun are not cheap

**Q182. Statements:** Atleast Music is Soul  
No Soul is Laptop  
All Laptops are Digital

**Conclusions:** I: Some Digital are not Music  
II: Some Digital are not Soul

**Q183. Statements:** Only a few evidence is strong

All strong are solid

All cement is solid

**Conclusions:** I. All cement being evidence is possibility

II. Some cement are not evidence

**Q184. Statements:** No Page is Layout

No Mail is Word

No Word is Layout

**Conclusions:** I. Some Pages are not Word

II. All Pages are Word

**Q185. Statements:** Some ancient are epic

Some epic are fight

No fight is small

**Conclusions:** I: All small can be epic

II: All epic can never be small

**Directions (186-188): Study the following information carefully and answer the given questions.**

Amongst Six persons, P, Q R, S, T and U each has different ages. T's age is more than P and R. Q is older than S. Only three persons are younger than S. P is not the youngest employee. The age of second youngest is 15yrs. U is older than Q.

**Q186.** Who among the following is eldest?

- (a) S
- (b) Q
- (c) R
- (d) P
- (e) None of these

**Q187.** How many persons are older than T?

- (a) One
- (b) Three
- (c) Two
- (d) More than three
- (e) None

**Q188.** If S age 36 years than what may be the age of Q?

- (a) 24yr
- (b) 48yr
- (c) 40yr
- (d) 9yr
- (e) Can't be determined

**Directions (189-190): In each of the questions below, some statements are given followed by some Conclusions. You have to take the given statements to be true even, if they seem to be at variance from commonly known facts. Read all the conclusions and then decide which of the given conclusions logically follows from the given statements disregarding commonly known facts.**

- (a) If only conclusion I follows.
- (b) If only conclusion II follows.
- (c) If either conclusion I or II follows.
- (d) If neither conclusion I nor II follows.
- (e) If both conclusions I and II follow.

**Q189. Statements:** Only a few Orange are Mango

All Mango are Litchi

Some litchi are Red

**Conclusions:** I. Some litchi are Orange

II. Some Red are mango

**Q190. Statements:** No water is hen

All hen are Queen

Some Queen are Tree

**Conclusions:** I. Some tree are water

II. Some queen are not water

**Directions (191-195): Read the given information carefully and answer the questions:**

Seven boxes are placed one above another. Each box contains different numbers of flower i.e., 14, 17, 40, 25, 32, 9 and 16 but not necessarily in the same order.

There are three boxes that are placed between box A and the one which contain maximum number of flowers. More than four boxes are placed above box C. Box E does not contain maximum number of flowers. Box G contain number of flowers which is perfect square of an even number. Number of boxes placed between box G and box D is half the number of boxes placed between box G and box C which contain number of flowers which is perfect square of an odd number. Difference between numbers of flowers is 5 in box D and box F which is placed just below box D. Box E is placed below box B. Box A contain 15 flowers more than box E. Box B is placed below box A.

**Q191.** What is the number of flowers in box D?

- (a) 32
- (b) 25
- (c) Either 14 or 9
- (d) 14
- (e) 9

**Q192.** Difference between the number of flowers of the box which is placed at top of the stack and the box which is placed at the bottom is \_\_\_\_.

- (a) 15
- (b) 7
- (c) 20
- (d) 12
- (e) None of these

**Q193.** How many boxes are placed between box F and the box which contain 17 flowers?

- (a) One
- (b) Three
- (c) Two
- (d) More than three
- (e) None of these

**Q194.** Which among the following box is placed just above box C?

- (a) Box A
- (b) Box F
- (c) Box B
- (d) Box G
- (e) None of these

**Q195.** Which of the following box contain second highest number of flowers?

- (a) Box C
- (b) None of these
- (c) Box B
- (d) Box E
- (e) Box A

**Directions (196-198): Study the information carefully and answer the questions given below.**

Dheeraj starts his journey from point S and walks 10m towards North to reach at point D, then takes a right turn and walks 6m to reach point F. From point F, he starts walking in west direction and walk 4m to reach at point N, from point N he takes a left turn and walks 9m to reach at point M, then takes a left turn again and walks 4m to reach point T.

**Q196.** What is the shortest distance between point T and point F?

- (a) 6m
- (b) 5m
- (c) 8m
- (d) 9m
- (e) None of these

**Q197.** In which direction is point N with respect to point T?

- (a) North
- (b) North east
- (c) South east
- (d) North west
- (e) Can't be determined

**Q198.** If point K is 2m north of point S, then what is the shortest distance between point D and point K?

- (a) 6m
- (b) 8m
- (c) 3m
- (d) 10m
- (e) None of these

**Directions (199-200): Study the information carefully and answer the questions given below.**

A person starts walking from point X to the east direction, after walking of 5km he reaches point P from there he turns towards left and then walk 4km to reach point Q. Then turn to his right and walk 5km to reach point R then turn to his right and walk 4km to reach point S, then move towards his left and walk 3km to reach point T then again turn right and walk 3km to reach point U finally turn to his right and walk 8km to reach point Y.

**Q199.** How far (Shortest Distance) and in which direction is point X with respect to point Y?

- (a)  $\sqrt{30}$  km, North
- (b) 34 km, North-East
- (c)  $2\sqrt{34}$  km, South-West
- (d)  $\sqrt{34}$  km, North-West
- (e) None of these.

**Q200.** In which direction is point T with respect to point Y?

- (a) North east
- (b) South east
- (c) North
- (d) West
- (e) South west

**Directions (201-205): Answer the following question based on the information given below.**

Eight persons-A, B, C, D, E, F, G and H are sitting around two circles such that one circle is inside the other. Four persons are sitting around the inner circle and faces outwards while four persons are sitting around the outer circle and faces inwards but not in the same order. Each person around the inner circle faces the person sitting around the outer circle. Also, each of them owns a different item Pen, Pencil, Marker, Eraser, Laptop, Speaker, Watch and Mobile but not in the same order.

G owns a laptop and faces the person who owns Marker. The person who owns Watch sits second to the right of G and immediate right to the person who sits opposite to the person who owns Pen. D owns Pencil and sits around the outer circle. A sits opposite to D and owns neither Watch nor Pen. C sits around the inner circle and faces the person who owns speaker. H faces B who owns Eraser. F does not sit around the outer circle.

**Q201.** Which of the following item does C own?

- (a) Pen
- (b) Marker
- (c) Watch
- (d) Speaker
- (e) None of these

**Q202.** Who among the following person owns Watch?

- (a) E
- (b) H
- (c) D
- (d) B
- (e) None of these

**Q203.** Who among the following person is not sitting at the outer circle?

- (a) D
- (b) H
- (c) A
- (d) G
- (e) None of these

**Q204.** Which of the following is false based on the given arrangement?

- (a) C owns Pen
- (b) D and H, sit on same table
- (c) F owns Marker and faces G
- (d) E is sitting around the inner circle
- (e) None is false

**Q205.** Who is sitting immediate right to the person who owns laptop?

- (a) The person with speaker
- (b) A
- (c) The person with eraser
- (d) The person with Watch
- (e) None of the above

**Directions (206-210):** Study the following information carefully and answer the questions given below:

In a certain code language:

- 'Casual bottle light' is written as 'rm tr jk',
- 'Volume report product' is written as 'mo sv lr',
- 'Light product Volume' is written as 'sv rm lr'
- 'Casual light Volume' is written as 'rm jk lr'.

**Q206.** What is the code for 'Volume light' in the given code language?

- (a) mo lr
- (b) jk sv
- (c) sv lr
- (d) lr rm
- (e) None of these

**Q207.** What is the code for 'casual' in the given code language?

- (a) mo
- (b) tr
- (c) jk
- (d) lr
- (e) None of these

**Q208.** What is the code for 'light product' in the given code language?

- (a) jk tr
- (b) rm sv
- (c) lr mo
- (d) sv lr
- (e) None of these

**Q209.** What may be the code for 'bottle casual rain'?

- (a) lr sv mo
- (b) tr ni jk
- (c) tr lr ta
- (d) mo jk lr
- (e) None of these

**Q210.** What is the code for 'report' in the given code language?

- (a) mo
- (b) jk
- (c) sv
- (d) lr
- (e) None of these

**Directions (211-213):** Study the following information carefully and answer the questions given below.

There are eight persons in a family. In this family, there are three married couples and three generations. P is grandfather of T. V is daughter-in-law of Q who is mother of O. U is father-in-law of V. O is granddaughter of R. T is not unmarried. S is brother-in-law of U. R has only one daughter.

**Q211.** Who among the following is grandson of R?

- (a) S
- (b) T
- (c) Either T or S
- (d) U
- (e) None of these

**Q212.** Who among the following is niece of S?

- (a) Q
- (b) Either O or V
- (c) V
- (d) O
- (e) None of these

**Q213.** Who among the following is father of T?

- (a) Either S or U
- (b) S
- (c) U
- (d) R
- (e) None of these

**Q214.** There are two generations and two married couple in the family. There are five members in this family. A is mother-in-law of B. D is father of C. A has only one son. C is nephew of E. A has no sibling. E is unmarried women. Then who among the following is father-in-law of B?

- (a) D
- (b) D's sibling
- (c) C
- (d) Either D or C
- (e) None of these

**Q215.** Introducing a boy, a girl says, "He is the son of the only sister of my mother's brother." How is the boy related to that girl?

- (a) Father-in-law
- (b) Brother
- (c) Cousin
- (d) Niece
- (e) Son

**Directions (216-220):** Study the following alphabetical sequence and answer the questions following it.

**A B B C D E F E I B C A F E C B B A C A O B N U**

**V W**

**Q216.** How many B's are in the alphabetical series which are immediately preceded by a vowel and immediately followed by consonant?

- (a) One
- (b) Two
- (c) Three
- (d) More than three
- (e) None of these

**Q217.** If all the vowels are dropped from the series, then which alphabet will be eighth from the right end?

- (a) C
- (b) B
- (c) N
- (d) F
- (e) None of these

**Q218.** How many consonants are in the alphabetical series which are immediately preceded by a Vowel?

- (a) One
- (b) Two
- (c) Four
- (d) None
- (e) More than Five

**Q219.** If the position of 1<sup>st</sup> and the 14<sup>th</sup> alphabets, 2<sup>nd</sup> and the 15<sup>th</sup> alphabets, and so on up to the 13<sup>th</sup> and the 26<sup>th</sup> alphabets, are interchanged, then which alphabet will be 7<sup>th</sup> to the right of 10<sup>th</sup> alphabet from the right end?

- (a) A
- (b) C
- (c) N
- (d) B
- (e) None of these

**Q220.** How many total vowels are in the alphabetical series?

- (a) Five
- (b) Ten
- (c) Eleven
- (d) Nine
- (e) None of these

**Directions (221-225):** Study the following information and answer the given questions.

Eight persons live on different floors of an eight-storey building such that the bottommost floor is numbered as 1, floor just above it is number as 2 and so on. Only one person lives on one floor. Their names are consecutive alphabets in alphabetical order starting from the bottommost floor. Each of them likes different sports-Cricket, Hockey, Football, Tennis, Kabaddi, Chess, Boxing and Archery but not necessarily in the same order.

Three persons live between the person who likes Hockey and S who likes Tennis. Neither R nor N likes Cricket. The person who likes Kabaddi lives immediately above the person who likes Boxing. The person who likes Cricket lives on an odd number floor. S who lives on an even numbered floor lives immediately below the person who likes Chess. Neither R nor V likes Kabaddi. The number of persons live above the person who likes Archery is the same as the number of persons live below the person who likes Cricket.

**Q221.** Who among the following lives on the bottommost floor?

- (a) The one who likes Football
- (b) The one who likes Chess
- (c) The one who likes Boxing
- (d) The one who likes Archery
- (e) The one who likes Cricket

**Q222.** How many persons live between R and the one who likes Hockey?

- (a) One
- (b) Two
- (c) Three
- (d) More than three
- (e) None of these

**Q223.** Who among the following person likes Cricket?

- (a) W
- (b) U
- (c) T
- (d) Y
- (e) V

**Q224.** T likes \_\_\_\_\_ and lives immediately below the person who likes \_\_\_\_\_.

- (a) Hockey, Boxing
- (b) Tennis, Kabaddi
- (c) Chess, Archery
- (d) Football, Hockey
- (e) Cricket, Tennis

**Q225.** Four from the following are similar in a certain way and forms a group. Find out the one which does not belong to that group.

- (a) R - Tennis
- (b) S - Chess
- (c) U - Cricket
- (d) W - Hockey
- (e) X - Kabaddi

**Directions (226-230): Study the information carefully answers the questions given below.**

! means either hour hand or minute hand is at 1

@ means either hour hand or minute hand is at 5

# means either hour hand or minute hand is at 8

\$ means either hour hand or minute hand is at 10

% means either hour hand or minute hand is at 12

& means either hour hand or minute hand is at 4

Note: if two symbols are given then by default first symbol is consider as an hour hand and second one is considered as minute hand.

**Q226.** If a train leaves at !@, and reaches its destination in 4 hours, then at what time does it reaches its destination?

- (a) @@
- (b) @!
- (c) \$\$
- (d) #&
- (e) none of these

**Q227.** It takes 4hrs 05 min for Vanya to reach her home from office. But she got late by 15mins and reached home at #&. At what time did she leave her office?

- (a) %%
- (b) \$%
- (c) #@
- (d) &%
- (e) none of these

**Q228.** Kriti booked a cab to attend a conference and the cab charged Rs.6/km. If she boarded the cab at !@ and reached conference at &#. What amount of money did she pay for the cab (in Rs.)?

- (a) 250
- (b) 450
- (c) 216
- (d) 1000
- (e) Can't be determined

**Q229.** Arun usually wake up at #%, and reaches his office at \$! but today he woke up late by 10 mins and also got stuck in traffic for 5mins. At what time will he reach his office today?

- (a) \$&
- (b) \$%
- (c) #%
- (d) @@
- (e) None of these

**Q230.** If a bus starts from Greater Noida at @# and reaches Delhi at #&, what is the speed of the bus (in km/h) if the distance between the two stops is 56km?

- (a) 12
- (b) 16
- (c) 15
- (d) 21
- (e) None of these

**Directions (231-235): Study the information carefully and answer the questions given below.**

Six persons are living in a building such that the ground floor is numbered 0, the floor just above it is numbered 1 and so on till the topmost floor is numbered 5. The addition of the floor numbers of E and A is one less than the floor number on which C lives. D lives just above F. A does not belongs to Surat. At least one person lives between the one who belongs to Pune and D. Not more than one person lives between B and E. Three persons live between A and the one who belongs to Vadodara. B belongs to Gandhinagar. The one is from Surat does not live adjacent to the one who belongs to Vadodara. Equal number of persons live between D and E and the ones belonging to Ahmedabad and Mumbai. The one who belongs to Mumbai lives above the one who belongs to Vadodara.

**Q231.** Who among the following belongs to Mumbai?

- (a) E
- (b) F
- (c) C
- (d) A
- (e) None of these

**Q232.** How many persons live between F and the one belonging to Ahmedabad?

- (a) Two
- (b) One
- (c) Three
- (d) Four
- (e) None of these

**Q233.** On which of the following floors does C live?

- (a) 1st
- (b) 2nd
- (c) 3rd
- (d) 4th
- (e) None of these

**Q234.** Who among the following belongs to Pune?

- (a) E
- (b) F
- (c) C
- (d) A
- (e) None of these

**Q235.** Four of following form a group, find the one that does not belong to that group?

- (a) E, C
- (b) F, B
- (c) C, B
- (d) B, A
- (e) A, E

**Directions (236-240):** Answer the questions based on the information given below.

A certain number of persons sit in a row facing south direction. G sits 4th to the right of W who sits 3rd to the left of P. The number of persons sit between P and W is same as the number of persons sit to the right of G. E sits 3rd to the left of A. Six persons sit between E and F. H sits fifth to the right of F. Five persons sit between P and A. Four persons sit to the left of A.

**Q236.** Who sits 3<sup>rd</sup> to the right of A?

- (a) F
- (b) H
- (c) G
- (d) W
- (e) None of these

**Q237.** Who sits 2<sup>nd</sup> from the right end of the row?

- (a) P
- (b) W
- (c) H
- (d) E
- (e) Unknown person

**Q238.** How many persons sit between H and W?

- (a) Five
- (b) Six
- (c) Four
- (d) Three
- (e) None of these

**Q239.** What is the position of W with respect to E?

- (a) 7<sup>th</sup> to the right
- (b) Immediate left
- (c) 6<sup>th</sup> to the right
- (d) 5<sup>th</sup> to the left
- (e) None of these

**Q240.** How many persons are sitting in the row?

- (a) 13
- (b) 14
- (c) 15
- (d) 16
- (e) None of these

**Directions (241-244):** The question given below consists of two statements numbered I and II given below it. You have to decide whether the data provided in the statements are sufficient to answer the question. Read all the statements and give answer.

**Q241.** How will 'chess most success' be coded in the given language?

**Statements:**

I. In a certain code language, 'rat caught chess trap' is coded as 'pq, st, op, wx', 'trap caught most' is coded as 'wx, st, ab' and 'rat trap success' is coded as 'Im, wx, op'.

II. In a certain language, 'fail success wealth' is coded as 'cd, yz, Im', 'stop wealth with most' is coded as 'ef, ab, yz, gh' and 'stop with chess fail' is coded as 'pq, cd, ef, gh'.

- (a) The data in statement I alone are sufficient to answer the question, while the data in statement II alone are not sufficient to answer the question.
- (b) The data in statement II alone are sufficient to answer the question, while the data in statement I alone are not sufficient to answer the question.
- (c) The data either in statement I alone or in statement II alone are sufficient to answer the question.
- (d) The data given in statements I and II together are not sufficient to answer the question.
- (e) The data in statements I and II together are necessary to answer the question.



**Q242.** Six people A, B, C, D, E and F sit at a certain distance in the park. What is the direction of F with respect to B?

**Statements:**

I. A is 3m to the west of B. C is 4m to the north of B. E is 8m to the south of A. D is 6m to the east of E. F is 4m to the west of D.

II. A is 10m to the north-west of D. E is 8m to the south of A. F is 2m to the east of E. F is to the west of D. C is 5m to the northeast of A. B is 3m to the south of C.

(a) The data in statement I alone are sufficient to answer the question, while the data in statement II alone are not sufficient to answer the question.

(b) The data in statement II alone are sufficient to answer the question, while the data in statement I alone are not sufficient to answer the question.

(c) The data either in statement I alone or in statement II alone are sufficient to answer the question.

(d) The data given in statements I and II together are not sufficient to answer the question.

(e) The data in statements I and II together are necessary to answer the question.

**Q243.** Eight cars M, N, O, P, Q, R, S and T are parked in a linear row in the parking area and face in north direction. Which car is parked 3rd to the right of N?

**Statements:**

I. M is parked second from the right end. Two cars are parked between M and S. N is parked adjacent to S.

II. P is parked second to the left of N. Three cars are parked between P and Q.

(a) The data in statement I alone are sufficient to answer the question, while the data in statement II alone are not sufficient to answer the question.

(b) The data in statement II alone are sufficient to answer the question, while the data in statement I alone are not sufficient to answer the question.

(c) The data either in statement I alone or in statement II alone are sufficient to answer the question.

(d) The data given in statements I and II together are not sufficient to answer the question.

(e) The data in statements I and II together are necessary to answer the question.

**Q244.** Seven people A, B, C, D, E, F and G live in a 7-storey building, such that the bottommost floor is numbered as 1 and topmost floor is numbered as 7. How many people live above G?

**Statements:**

I. Two people live between A and E. G lives just below E. C lives two floors above F.

II. B lives two floors below A. E lives four floors below C. D lives below F.

(a) The data in statement I alone are sufficient to answer the question, while the data in statement II alone are not sufficient to answer the question.

(b) The data in statement II alone are sufficient to answer the question, while the data in statement I alone are not sufficient to answer the question.

(c) The data either in statement I alone or in statement II alone are sufficient to answer the question.

(d) The data given in statements I and II together are not sufficient to answer the question.

(e) The data in statements I and II together are necessary to answer the question.

**Directions (245-248):** The question given below consists of two statements numbered I and II given below it. You have to decide whether the data provided in the statements are sufficient to answer the question. Read all the statements and give answer.

**Q245.** Seven boxes L, M, N, O, P, Q and R, are kept one above the other, such that the bottommost box is numbered as 1, the box above it is numbered as 2 and so on. How many boxes are between R and O?

**Statements:**

I. M is three boxes above L. L is an even numbered box. R is kept immediately above M. There is one box between M and N. There are two boxes between Q and P which is a prime numbered box.

II. M is four boxes above O. P is two boxes above M. Q is two boxes below R. N is above L.

(a) The data in statement I alone are sufficient to answer the question, while the data in statement II alone are not sufficient to answer the question.

(b) The data in statement II alone are sufficient to answer the question, while the data in statement I alone are not sufficient to answer the question.

(c) The data either in statement I alone or in statement II alone are sufficient to answer the question.

(d) The data given in statements I and II together are not sufficient to answer the question.

(e) The data in statements I and II together are necessary to answer the question.

**Q246.** In a certain code language, "Hence Banking examination" is coded as "stu pqr rmn". "Banking Jobs are difficult" is coded as "Imn opq pqr bcd". What is the code for "Difficult examination pattern"?

**Statements:**

I. "Difficult track road" is coded as "jkl hij opq" and "Hence examination pattern" is coded as "stu mno rmn" in the same coding language.

II. "Pattern are difficult is coded as "Imn mno opq" and "Hence difficult Road" is coded as "opq rmn hij" in the same coding language.

(a) The data in statement I alone are sufficient to answer the question, while the data in statement II alone are not sufficient to answer the question.

(b) The data in statement II alone are sufficient to answer the question, while the data in statement I alone are not sufficient to answer the question.

(c) The data either in statement I alone or in statement II alone are sufficient to answer the question.

(d) The data given in statements I and II together are not sufficient to answer the question.

(e) The data in statements I and II together are necessary to answer the question.

**Q247.** Seven players S, T, U, V, W, X, and Y scored different runs in a match. At least three players scored more than 56 runs. Who scored the highest run?

**Statements:**

I. W scored more runs than Y but less than 56 runs. V doesn't score more than Y. U doesn't score 56 runs.

II. Runs scored by S is the average of the runs scored by X and U. T scored more than W but less than U. Y and V scored less than W. S scored more runs than U, but not the highest.

(a) The data in statement I alone are sufficient to answer the question, while the data in statement II alone are not sufficient to answer the question.

(b) The data in statement II alone are sufficient to answer the question, while the data in statement I alone are not sufficient to answer the question.

(c) The data either in statement I alone or in statement II alone are sufficient to answer the question.

(d) The data given in statements I and II together are not sufficient to answer the question.

(e) The data in statements I and II together are necessary to answer the question.

**Q248.** Eight persons P, Q, R, S, T, U, V and W are sitting in a row. All of them are facing the north. Who is sitting at the extreme left end?

**Statements:**

I. Three persons are sitting between P and Q who is sitting 2nd to the right of R. One person is sitting between P and V.

II. Two persons are sitting between S and R. T is not sitting in the right of W.

(a) The data in statement I alone are sufficient to answer the question, while the data in statement II alone are not sufficient to answer the question.

(b) The data in statement II alone are sufficient to answer the question, while the data in statement I alone are not sufficient to answer the question.

(c) The data either in statement I alone or in statement II alone are sufficient to answer the question.

(d) The data given in statements I and II together are not sufficient to answer the question.

(e) The data in statements I and II together are necessary to answer the question.

**Q249.** If 1 number is added to the even digits in the given number "36985247" and 2 is subtracted from the odd digits, then how many digits are repeated in the newly formed number?

(a) One

(b) Two

(c) Three

(d) Four

(e) Five

**Q250.** How many such pairs of letters are there in the word 'MILLENNIAL', each of which has as many letters between them (in both forward and backward directions) as they have between them in the English alphabetical series?

(a) One

(b) Two

(c) Three

(d) Four

(e) More than four

**Directions (251-252): Read the following information carefully and answer the given questions.**

D, L, N, X, W and V are six friends. Each of them has different weights. L is heavier than only N. W is lighter than only two people. V is not the heaviest. The difference between the weight of third lightest and the lightest person is 12kg. D is heavier than W but is not the heaviest. The weight of V is 70 kg.

**Q251.** How many persons are heavier than V?

- (a) Four
- (b) Three
- (c) Two
- (d) One
- (e) None of these

**Q252.** Which of the following statement is true if weight of L is 66 kg?

- (a) The difference between the weight of V and L is 6 kg.
- (b) Weight of W is 65 kg.
- (c) Weight of D is 24 kg.
- (d) The difference between the Weight of L and N is 8 kg.
- (e) None is true

**Q253.** Deepak ranked 31st from the bottom and 13th from the top among the boys who passed an exam. Six boys did not participate in the exam and four boys failed in it. How many boys were there in the class?

- (a) 54
- (b) 55
- (c) 52
- (d) 53
- (e) 51

**Q254.** In a row of boys, Aman is tenth from the right end and Babloo is eighth from the left end. If in this row Babloo is twelfth from the right then what is the position of Aman from the left?

- (a) 9
- (b) 10
- (c) 11
- (d) 12
- (e) None of these

**Q255.** Harmaini is 19<sup>th</sup> from the left end of a row of 37 students and Harry is 16<sup>th</sup> from the right end in the same row. How many students are there between them in the row?

- (a) 1
- (b) 3
- (c) 5
- (d) 4
- (e) 2

**Directions (256-260):** Study the information carefully and answer the questions given below.

Six boxes J, K, L, M, N and O are placed one above another in a stack. They all are different in colour i.e., Black, Blue, Orange, Green, white and Grey but not necessarily in same order.

Three boxes are placed between box L and Box K. Black colour box is placed immediately above box K. One box is placed between box O and box M which is blue in colour. Box O is placed above black colour box. Green colour box is placed above white colour box. One box is placed between box L and white colour box. Box O is placed above box L which is not green and orange colour. Box N is not white colour.

**Q256.** How many boxes are placed between box J and box O?

- (a) Two
- (b) More than Four
- (c) One
- (d) Three
- (e) Four

**Q257.** Which of the following box is placed at bottommost position?

- (a) Black colour box
- (b) Blue colour box
- (c) Orange colour box
- (d) Green colour box
- (e) Grey colour box

**Q258.** Which of the following box is white colour?

- (a) Box O
- (b) Either box O or box K
- (c) Box K
- (d) Box L
- (e) None of these

**Q259.** Which of the following combination is correct?

- (a) K-Blue
- (b) L-Grey
- (c) O-White
- (d) J-Green
- (e) N-Orange

**Q260.** Four of the following five are alike in certain way based from a group, find the one that does not belong to that group?

- (a) J-Grey
- (b) L-White
- (c) N-Orange
- (d) O-Blue
- (e) J-Orange

**Directions (261-265):** In each of the questions below some statements are given followed by some conclusions. You have to take the given statements to be true even if they seem to be at variance with commonly known facts. Read all the conclusions and then decide which of the given conclusions logically follows from the given statements disregarding commonly known facts.

- (a) If only conclusion I follows
- (b) If only conclusion II follows
- (c) If either conclusion I or II follows
- (d) If neither conclusion I nor II follows
- (e) If both conclusions I and II follow

**Q261. Statements:**  $P > Y \leq H \geq U > T = N$

**Conclusions:** I.  $P > U$                       II.  $N < H$

**Q262. Statements:**  $A \geq S > D = C \geq V > F > G \geq H$

**Conclusions:** I.  $V < D$                       II.  $H \leq V$

**Q263. Statements:**  $F > G \geq T \geq H > Y, T \leq L = J < K$

**Conclusions:** I.  $J > H$                       II.  $J = H$

**Q264. Statements:**  $B > N \geq M = K > L, W \leq E = B, Q \geq W > A$

**Conclusions:** I.  $W > M$                       II.  $Q \leq K$

**Q265. Statements:**  $C > V = B > N \geq M, K \leq L = O \leq P < V$

**Conclusions:** I.  $O < C$                       II.  $B > L$

**Q266.** In a certain code language, 'TABLE' is coded as 'BUCFM' and 'PRAYS' is coded as 'SQBTZ', then how 'MAJOR' will be coded in the same manner?

- (a) BNSQP
- (b) BONSP
- (c) BNOSP
- (d) BNSPO
- (e) BNKSP

**Q267.** How many such pairs of letters are in the word 'ARCHEOLOGY' each of which has as many letters between them (in both forward and backward directions) as they have between them in the English alphabetical series?

- (a) One
- (b) Two
- (c) Three
- (d) Four
- (e) More than four

**Q268.** In the given words, if the 1<sup>st</sup> and 5<sup>th</sup> letters (from the left end) are interchanged and same is done with 3<sup>rd</sup> and 9<sup>th</sup> letters, 6<sup>th</sup> and 10<sup>th</sup> letters then which series would form an English meaningful word after the rearrangement?

- I. RENIRTMETE
- II. ADOTRNTIAA
- III. LNOUINTISA
- (a) Only I
- (b) Only III
- (c) Only I and II
- (d) Only II and III
- (e) Only I and III

**Q269.** If the vowels of the following words are arranged first as per the alphabetical order followed by the consonants as per the alphabetical order and the vowels are changed to the previous letter and consonants are changed to the next letter in the alphabetical series, then which will be the third letter from the right end of each newly formed word in the same order?

- I. PERFORM
- II. REVENUE
- III. EMPLOY
- (a) QON
- (b) PON
- (c) OGH
- (d) POM
- (e) None of these

**Q270.** If we arrange all the alphabets of the word DELIBRATELY in the alphabetical order from left end then the place of how many alphabets will remain unchanged after the rearrangement?

- (a) One
- (b) Two
- (c) Three
- (d) Four
- (e) None of these

**Directions (271-275):** In these questions, relationship between different elements is shown in the statements. These statements are followed by two conclusions. Mark answer as:

- (a) If only conclusion I follows
- (b) If only conclusion II follows
- (c) If either conclusion I or II follows
- (d) If neither conclusion I nor II follows
- (e) If both conclusions I and II follow

**Q271. Statements:**  $A \leq E, F \geq B < C < A$

**Conclusions:** I.  $B < E$     II.  $F > A$

**Q272. Statements:**  $G > O, K \geq G < F \leq L < M$

**Conclusions:** I.  $O \geq L$  II.  $K \geq O$

**Q273. Statements:**  $V > Q > M > X = S, Q \geq T > N$

**Conclusions:** I.  $N > X$  II.  $N \leq S$

**Q274. Statements:**  $R \geq Y > Q, U < Q, X < Y \geq P$

**Conclusions:** I.  $X > U$  II.  $P \leq R$

**Q275. Statements:**  $O \geq J < Y = Z > I > R$

**Conclusions:** I.  $O \geq I$  II.  $R < Y$

**Directions (276-280):** In each of the questions below, three statements are given followed by two conclusions numbered I and II. You have to take the given statements to be true even if they seem to be at variance with commonly known facts. Read all the conclusions and then decide which of the given conclusions logically follows from the given statements disregarding commonly known facts.

**Q276. Statements:** All sand are water.

No fruit is pen.

Some pen are sand.

**Conclusions:** I. All fruit are not sand.

II. All water being fruit is a possibility.

- (a) Only II follows
- (b) Only I follows
- (c) Either I or II follow
- (d) Both I and II follows
- (e) None follows

**Q277. Statements:** All Quagmires are Digital

No Digital is Government

All Government are Dumb

**Conclusions:** I. Some digital can be Dumb

II. All Dumb can never be Digital

- (a) Only II follows
- (b) Only I follows
- (c) Either I or II follow
- (d) Both I and II follows
- (e) None follows

**Q278. Statements:** Some kind are man.

All Man are Cash.

No Cash is a Cheque

**Conclusions:** I. No man is cheque

II. Some cash is kind

- (a) Only II follows
- (b) Only I follows
- (c) Either I or II follow
- (d) Both I and II follows
- (e) None follows

**Q279. Statements:** Some graph are Fish

Some fish are sparrow

Some sparrow are Eagle

**Conclusions:** I. Some Fish are Eagle

II. No Eagle is Fish

- (a) Only II follows
- (b) Only I follows
- (c) Either I or II follow
- (d) Both I and II follows
- (e) None follows

**Q280. Statements:** All iron are Eight

No Eight is Two

All Two are Four

**Conclusions:** I. No iron is Two

II. Some four can be Eight

- (a) Only II follows
- (b) Only I follows
- (c) Either I or II follow
- (d) Both I and II follows
- (e) None follows

**Directions (281-285):** Study the following information carefully and answer the questions given below.

Eight persons i.e. A, B, C, D, E, F, G and H are sitting around a square table. Four of them sit at corner face inside and like different flowers i.e., Lotus, Lily, Sunflower and Rose and remaining four persons sit at middle side of square table face outside the center and like different fruits i.e., Mango, Grapes, Orange and Apple. All information is not necessarily in the same order.

Two persons sit between C and the one who likes lotus. The person who likes grapes sit third to the left of the person who likes lotus. One person sits between the one who likes lily and the one who likes sunflower. Three persons sit between A and F. D and B are immediate neighbor to each other. One person sits between C and the one who likes apple. G likes mango. E sits third to the right of G. B likes apple. C does not like grapes. The person who likes lily and the one who likes grapes are not immediate neighbor to each other. A sit second to the left of D.

**Q281.** Who among the following person sit immediate right of B?

- (a) F
- (b) D
- (c) G
- (d) A
- (e) None of these

**Q282.** Who among the following person likes Rose?

- (a) F
- (b) E
- (c) A
- (d) G
- (e) None of these

**Q283.** How many persons sit between F and G when counted to the left of G?

- (a) Two
- (b) One
- (c) Three
- (d) More than Three
- (e) None

**Q284.** Who among the following person sit second to the right of H?

- (a) The one who likes Lily
- (b) The one who likes Lotus
- (c) The one who likes Orange
- (d) The one who likes Mango
- (e) None of these

**Q285.** Four of the following five are alike in certain way-based form a group, find the one who does not belong to that group?

- (a) A
- (b) H
- (c) D
- (d) E
- (e) F

**Directions (286-290): Study the following information carefully and answer the questions given below.**

Six persons P, Q, R, S, T and U are living at seven storey building. Each of them like different Cars i.e., Maruti, Honda, Kia, BMW, Toyota and Volvo. All information is not necessarily in same order. One floor is vacant.

P live at 6<sup>th</sup> floor. One floor is between P and the one who likes Kia. Two persons live between the person who likes Honda and the one who likes Maruti. The person who likes Honda lives above the one who likes Maruti. Q likes BMW and lives at the bottommost floor. R lives immediately below P's floor and does not like Honda. Two persons live between U and T. One person lives between T and the one who likes Toyota. Vacant floor is one of the above floors of the person who likes Maruti.

**Q286.** Who among the following person likes Maruti car?

- (a) P
- (b) S
- (c) Q
- (d) T
- (e) R

**Q287.** Which of the following floor is Vacant?

- (a) 2<sup>nd</sup>
- (b) 7<sup>th</sup>
- (c) 5<sup>th</sup>
- (d) 1<sup>st</sup>
- (e) None of these

**Q288.** Which of the following combination is true?

- (a) R-BMW
- (b) P-Toyota
- (c) U-Kia
- (d) S-Honda
- (e) Q-Maruti

**Q289.** Four of the following five are alike in certain way based form a group, find the one that does not belong to that group?

- (a) Q-R
- (b) U-Q
- (c) T-R
- (d) U-P
- (e) S-R

**Q290.** Who among the following person likes Volvo car?

- (a) P
- (b) S
- (c) Q
- (d) T
- (e) R

**Directions (291-295): Study the information carefully and answer the following questions.**

Eight people i.e. A, B, C, D, E, F, G and H sit in a square-shaped table but not necessarily in the same order. Four people sit at the four corners of the table and face outside the table. Four people sit at the middle of the four sides and face inside the table. Two people sit between A and H who sits at the corner. B sits second to the left of H. Only one person sits between B and D. G sits second to the left of D. C sits second to the right of E. F does not sit adjacent to D and G.

**Q291.** Four of the following five are alike in a certain way and hence form a group. Find the one who doesn't belong to that group?

- (a) C
- (b) H
- (c) D
- (d) G
- (e) B

**Q292.** How many people sit between F and G when counted from right of G?

- (a) Four
- (b) Three
- (c) One
- (d) Two
- (e) None of these

**Q293.** Which statement is true?

- (a) D sits adjacent to G.
- (b) Two people sit between A and C.
- (c) E faces F
- (d) H faces inside the table
- (e) None of these

**Q294.** If all the people sit according to the English alphabetical order from A in clockwise direction, then how many people remains unchanged? (Excluding A)

- (a) Two
- (b) One
- (c) Three
- (d) Four
- (e) None of these

**Q295.** Who sits fourth to the left of D?

- (a) C
- (b) H
- (c) F
- (d) A
- (e) None of these

**Q296.** Which of the following symbols should replace the question mark in the given expression to make  $A \geq D$  definitely true?

$$A = G \geq B ? F ? M = D$$

- (a)  $>, >$
- (b)  $=, >$
- (c)  $\leq, \leq$
- (d)  $\leq, <$
- (e) None of these

**Q297.** Which of the following symbols should replace the question mark(?) in the given expression in order to make the expressions  $A < B$  definitely true and  $D \leq A$  definitely true?

$$B ? E = A ? F \geq N = D$$

- (a)  $>, \leq$
- (b)  $=, >$
- (c)  $<, >$
- (d)  $>, =$
- (e)  $\leq, <$

**Q298.** Which of the following symbols should replace the question mark in the given expression to make  $N \geq D$  definitely true?

$$A = G \geq B, N ? F ? M = D, B > N$$

- (a)  $>, \geq$
- (b)  $=, >$
- (c)  $\leq, \leq$
- (d)  $\leq, <$
- (e) None of these

**Q299.** Which of the following symbols should replace the question mark (?) in the given expression in order to make the expressions  $M < E$  definitely false and  $B \leq A$  definitely true?

$$M ? B ? E = A$$

- (a)  $>, \leq$
- (b)  $=, >$
- (c)  $<, >$
- (d)  $=, =$
- (e)  $\leq, <$

**Q300.** Which of the following symbols should replace the question mark in the given expression to make  $G \geq F$  and  $M < B$  definitely true?

$$A ? G ? B ? F ? M$$

- (a)  $>, >, >, \leq$
- (b)  $=, >, >, \leq$
- (c)  $\leq, \leq, >, \leq$
- (d)  $\leq, <, >, \leq$
- (e) None of these



**Solutions**

**Solutions (1-5):**

Sol.

Words	Codes
Beast	lfo
Mafia	nui
of	ga
Lion	su
Red	zo
Burn	epi
Horn /on	ye/na
Spiritual	da
Energy	ra
Fire	nic

S1. Ans.(e)

S2. Ans.(d)

S3. Ans.(b)

S4. Ans.(e)

S5. Ans.(b)

S6. Ans.(d)

Sol.

Symbols	\$	@	%	#
Coded for	Son	Mother	Son-in law	Daughter

Given equation: P \$ R # M % N

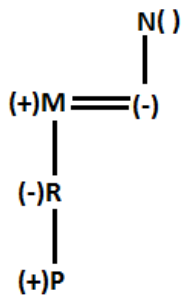

Since, the gender of N is not defined, the relationship between N and R can't be determined.

S7. Ans.(c)

Sol.

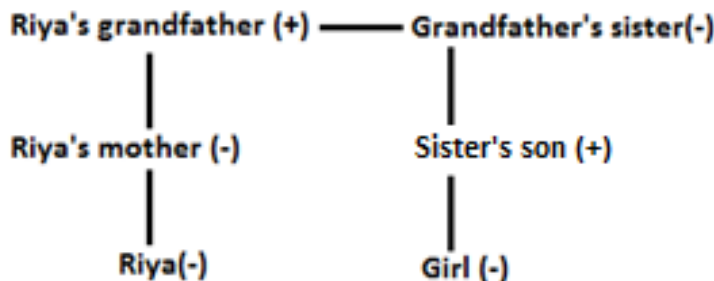

Clearly, Riya is girl's cousin.

**Solutions (8-9):**

S8. Ans.(e)

Sol.

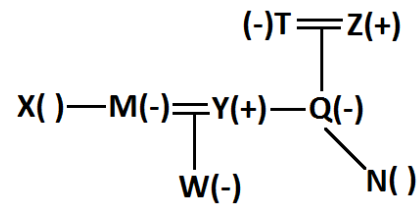

Since, the gender of N is not defined therefore, it can't be determined.

S9. Ans.(c)

Sol.

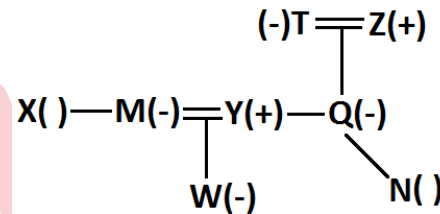

Since, the gender of X and N is not defined therefore, it can't be determined.

S10. Ans.(b)

Sol.

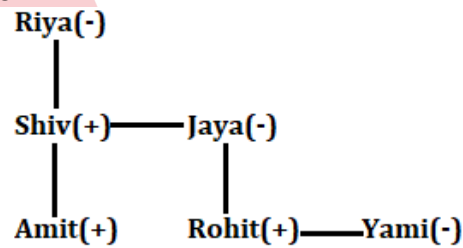

**Solutions (11-15):**

S11. Ans.(b)

Sol. The data in statement II alone is sufficient to answer the question.

From I: It is given that Gauri is 5th to Sonali but not given left or right

From II: Gini is 2nd from left end, and then Sonali is 6th to right of Gini, so Sonali is 8th from left end.

S12. Ans.(c)

Sol. If the data either in statement I alone or statement II alone are sufficient to answer the question.

From either statement, it says that there is no one between P and Q, or 0 students between P and Q.

S13. Ans.(d)

Sol. Both statements even together are not sufficient to answer.



S14. Ans.(e)

Sol. The data in both statements I and II together are necessary to answer the question.

From both, N is daughter-in-law of Q.

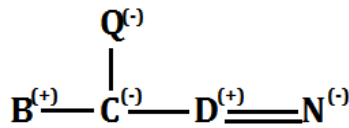

S15. Ans.(b)

Sol. If the data in statement II alone is sufficient to answer the question.

From I:  $C > D > A$

$E > B > A$

From II:  $C > E > B/D > D/B > A$

Solutions (16-20):

Sol.

Day	Person
Monday	U
Tuesday	Q
Wednesday	R
Thursday	T
Friday	P
Saturday	S

S16. Ans.(c)

S17. Ans.(a)

S18. Ans.(c)

S19. Ans.(e)

S20. Ans.(d)

Solution (21-25):

Sol.

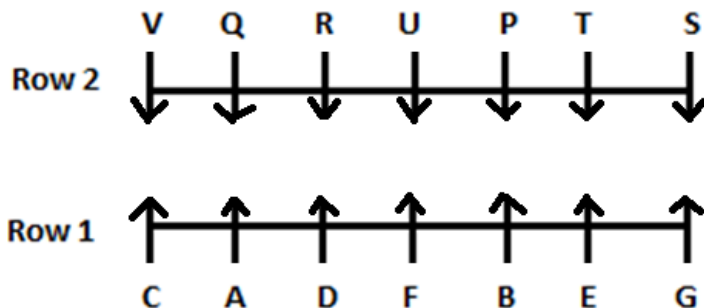

S21. Ans.(a)

S22. Ans.(d)

S23. Ans.(c)

S24. Ans.(c)

S25. Ans.(a)

Solution (26-30):

Sol.

Word	Code
Black	kl
Brown/Pink	nw/te
White	ip
Red/yellow	er/ol
Orange	gn
Magenta	ng
Grey/Green	yg/sr

S26. Ans.(d)

S27. Ans.(a)

S28. Ans.(e)

S29. Ans.(c)

S30. Ans.(d)

Solutions (31-35):

Sol.

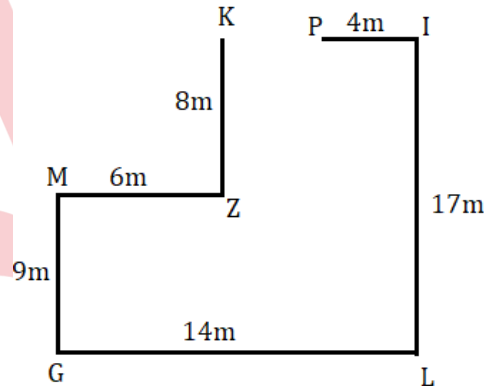

S31. Ans.(c)

S32. Ans.(b)

S33. Ans.(e)

S34. Ans.(a)

S35. Ans.(e)

Solution (36-40):

The first code (letter), is the last alphabet of the word.

The 2nd code (symbol), is symbols among @, %, &, #. So, we conclude that the word which contains 3 alphabets has '@' symbol, 4 alphabets has '%' symbol, 5 alphabets has '&' symbol and 6 alphabets has '#' symbol.

The last code (number), is the alphabetic position of the first alphabet of the word.

For example, the word 'These' contains 5 alphabets, so we would use '&' symbol.

Last letter of the word is E.

Position of the first letter i.e., T, in the word according to alphabetical series is 20. So, 'These' is coded as 'E&20'.

- S36. Ans.(a)  
S37. Ans.(b)  
S38. Ans.(c)  
S39. Ans.(d)  
S40. Ans.(c)

Solutions (41-45):

Sol.

Word	Code
Fixing	mn
Earth	ie
Food	as
Award	bn
Word	cd
Water	zq
No	st
Coaching/glass	zx/yx

- S41. Ans.(a)  
S42. Ans.(d)  
S43. Ans.(e)  
S44. Ans.(b)  
S45. Ans.(d)

Solutions (46-50):

Sol.

Floor	Person	Country
7	G	France
6	E	Germany
5	A	India
4	D	Russia
3	F	Japan
2	B	Australia
1	C	China

- S46. Ans.(d)  
S47. Ans.(c)  
S48. Ans.(a)  
S49. Ans.(d)  
S50. Ans.(b)

Solutions (51-53):

Sol.

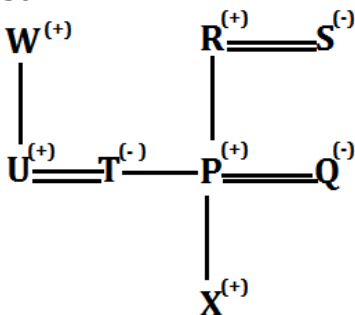

- S51. Ans.(b)  
S52. Ans.(d)  
S53. Ans.(a)

Solutions (54-56):

S54. Ans.(c)

Sol.

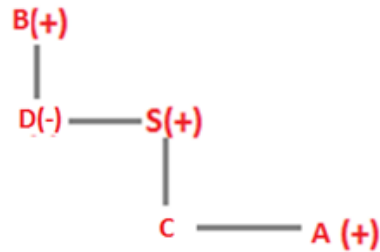

S55. Ans.(e)

S56. Ans.(a)

Sol.

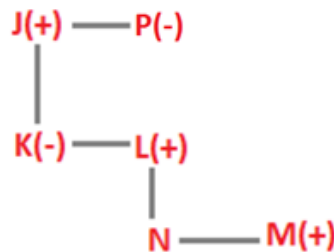

S57. Ans.(b)

S58. Ans.(a)

S59. Ans.(a)

Sol.

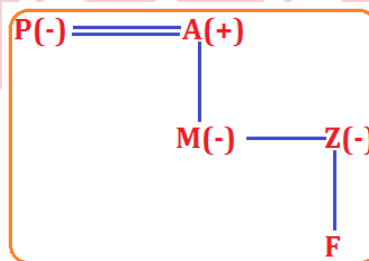

S60. Ans.(e)

Solutions (61-65):

S61. Ans.(e)

Sol.

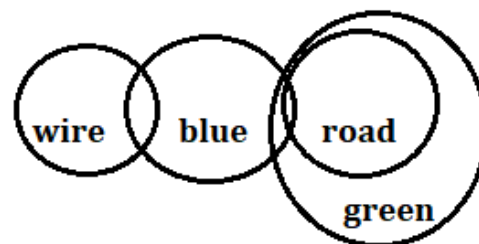

S62. Ans.(d)

Sol.

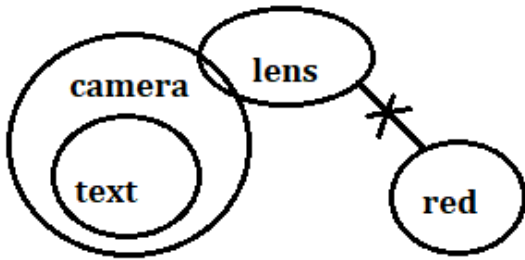

S63. Ans.(b)

Sol.

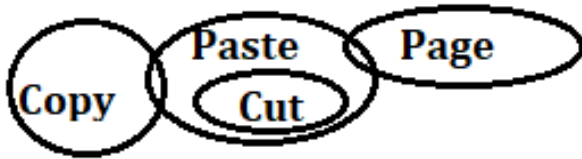

S64. Ans.(d)

Sol.

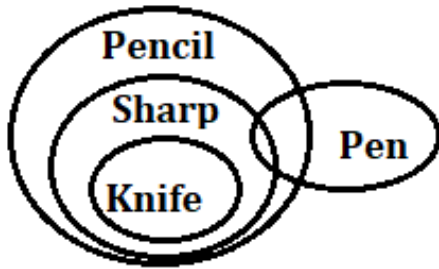

S65. Ans.(e)

Sol.

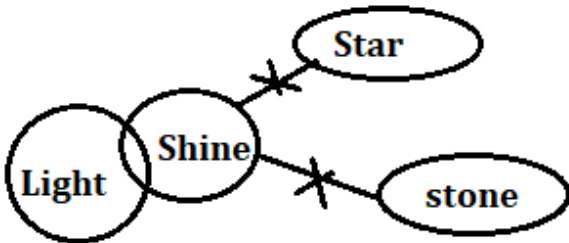

Solutions (66-68):

S66. Ans.(d)

Sol.

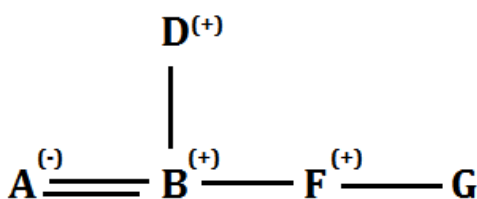

S67. Ans.(c)

Sol.

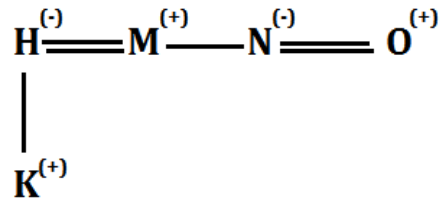

S68. Ans.(a)

Sol.

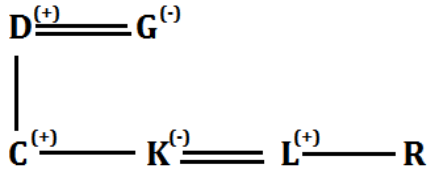

S69. Ans.(b)

S70. Ans.(e)

Sol.

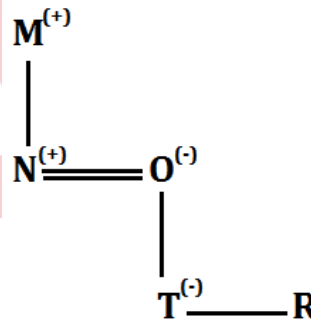

Solutions (71-75):

Sol.

Word	Code
Crown	we
Pen	jkl
Rub	op
Book	lp
Room	ir
Fan	fu
Bottle	ty
Wire	gb
Bulb/Light	xz/lo

S71. Ans.(b)

S72. Ans.(e)

S73. Ans.(c)

S74. Ans.(a)

S75. Ans.(b)

Solution (76-79):

Sol.

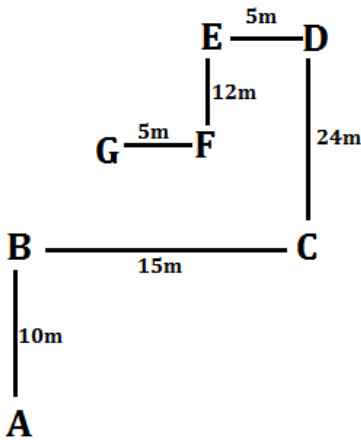

S76. Ans.(c)

S77. Ans.(b)

S78. Ans.(d)

S79. Ans.(c)

S80. Ans.(e)

Sol.

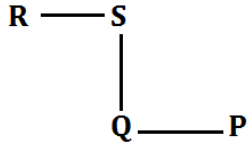

Solutions (81-85):

Sol.

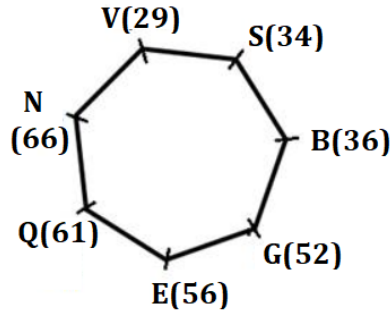

S81. Ans.(d)

S82. Ans.(c)

S83. Ans.(b)

S84. Ans.(d)

S85. Ans.(e)

Solutions (86-90):

Sol. Step I to Step IV: Prime numbers are arranged in ascending order from the left end and non-prime numbers are arranged from the right end in ascending order.

Step V: +2, -3, +2, -3....

Step VI to Step IX: Odd numbers are arranged in ascending order from the left end and even numbers are arranged from the right end.

Input: 25 58 47 33 23 73 64 61

Step I: 23 58 47 33 73 64 61 25

Step II: 23 47 58 73 64 61 25 33

Step III: 23 47 61 73 64 25 33 58

Step IV: 23 47 61 73 25 33 58 64

Step V: 25 44 63 70 27 30 60 61

Step VI: 25 27 44 63 70 60 61 30

Step VII: 25 27 61 63 70 60 30 44

Step VIII: 25 27 61 63 70 30 44 60

Step IX: 25 27 61 63 30 44 60 70

S86. Ans.(e)

S87. Ans.(d)

S88. Ans.(b)

S89. Ans.(c)

S90. Ans.(c)

Solutions (91-95):

Sol. The digit in the code is the number of consonants in the word.

The 1st letter in the code is the immediately succeeding letter (in alphabetical series) of the 2nd letter from the left end of the word.

The 2nd letter in the code is the immediately preceding letter (in alphabetical series) of the last letter from the left end of the word.

Example: 'Provision'

Number of consonants in the word is 5.

2nd letter from the left end of the word is "R". Immediate succeeding letter (in alphabetical series) of R is S.

Last letter from the left end of the word is "N". Immediately preceding letter (in alphabetical series) of N is M.

Therefore, the code for "provision" is "5SM".

NRA CET Ready ENGLISH MEDIUM

**BANK MAHAPACK Plus**

WITH ENGLISH MED. BOOK KIT

For ALL Bank Exams

IBPS PO & Clerk, SBI PO & Clerk, RRB PO & Clerk & All Major Public Sector Banking Exam

Live Classes, Video Courses, Test Series, eBooks & Books

- S91. Ans.(a)
- S92. Ans.(a)
- S93. Ans.(d)
- S94. Ans.(c)
- S95. Ans.(a)

Solution (96-100):

Sol.

Word	Code
Member	ki
Song	po
Mail	yt
Boat	uj
Dope	at
Complete	tu

- S96. Ans.(b)
- S97. Ans.(a)
- S98. Ans.(d)
- S99. Ans.(a)
- S100. Ans.(b)

Solutions (101-105):

Sol.

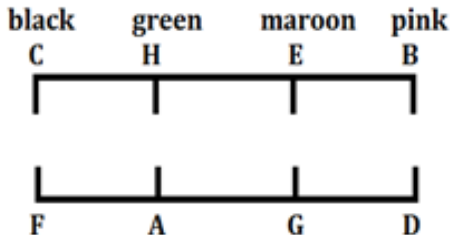

- S101. Ans.(b)
- S102. Ans.(e)
- S103. Ans.(e)
- S104. Ans.(a)
- S105. Ans.(e)

Solutions (106-108):

Sol.

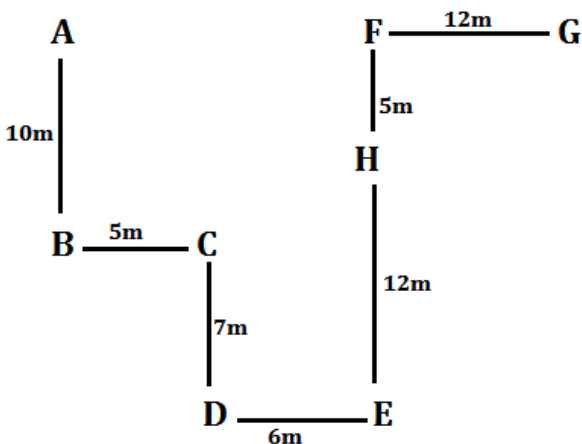

- S106. Ans.(d)
- S107. Ans.(b)
- S108. Ans.(a)

Solutions (109-110):

Sol.

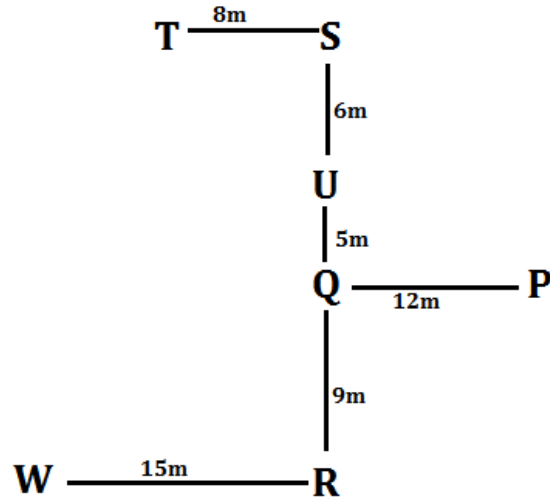

- S109. Ans.(b)
- S110. Ans.(b)

Solutions (111-115)

Sol.

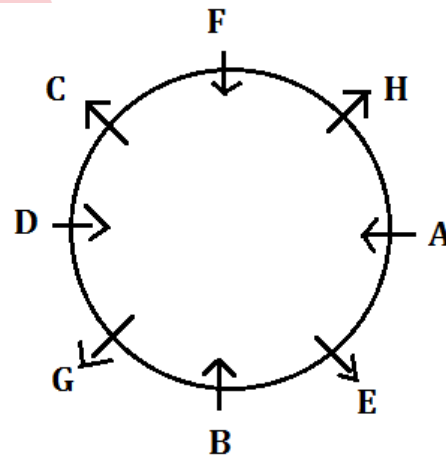

- S111. Ans.(b)
- S112. Ans.(d)
- S113. Ans.(c)
- S114. Ans.(a)
- S115. Ans.(d)

Solutions (116-120):

- S116. Ans.(a)

Sol.

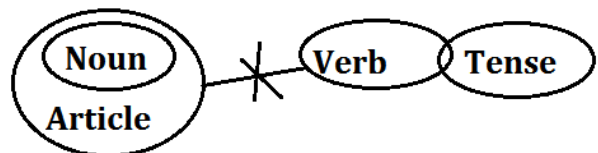

S117. Ans.(a)  
Sol.

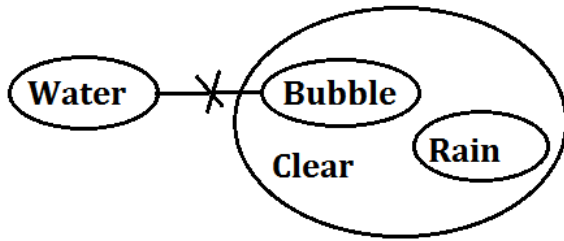

S118. Ans.(a)  
Sol.

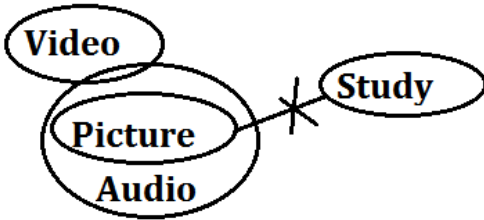

S119. Ans.(b)  
Sol.

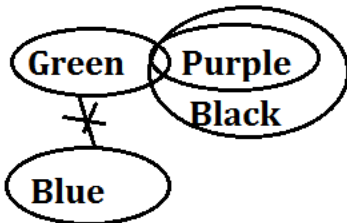

S120. Ans.(d)  
Sol.

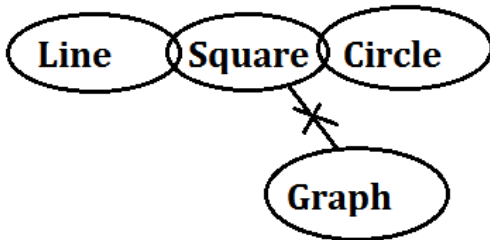

Solutions (121-125):

- S121. Ans.(c)  
Sol. I.  $F=K$ (FALSE)      II.  $F>K$ (FALSE)
- S122. Ans.(a)  
Sol. I.  $T<J$ (TRUE)      II.  $J<Z$ (FALSE)
- S123. Ans.(e)  
Sol. I.  $G\geq Z$  (TRUE)      II.  $C\geq R$  (TRUE)
- S124. Ans.(d)  
Sol. I.  $E>C$ (FALSE)      II.  $F>B$ (FALSE)
- S125. Ans.(e)  
Sol. I.  $O<M$ (TRUE)      II.  $O<K$ (TRUE)

Solutions (126-127):

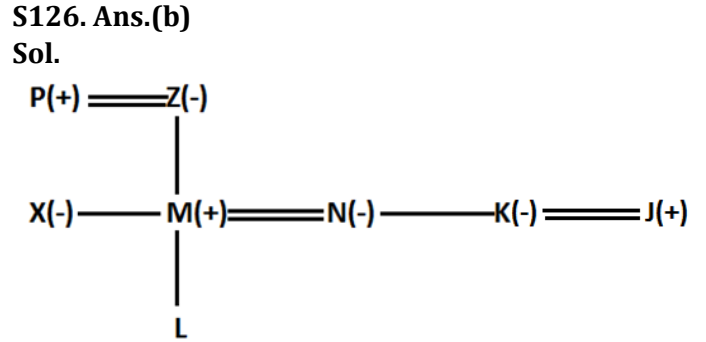

S127. Ans.(e)  
Sol.

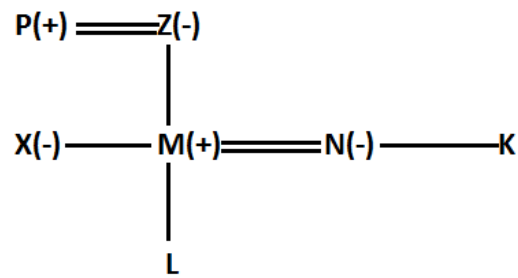

Solutions (128-130):

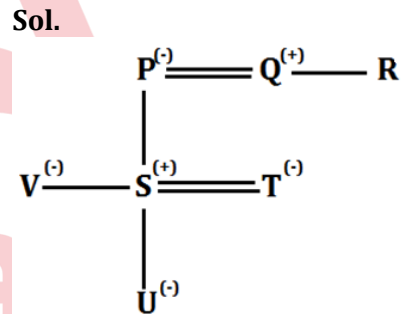

S128. Ans.(a)  
S129. Ans.(e)  
S130. Ans.(d)

Solutions (131-135):

Sol.

Date	11 <sup>th</sup>	22 <sup>nd</sup>
Month		
January	B	H
March	E	C
April	D	A
May	G	F

S131. Ans.(e)  
S132. Ans.(d)  
S133. Ans.(d)  
S134. Ans.(c)  
S135. Ans.(e)

**Solutions (136-140)**

Sol.

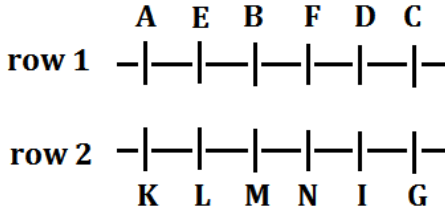

- S136. Ans.(c)
- S137. Ans.(a)
- S138. Ans.(d)
- S139. Ans.(e)
- S140. Ans.(b)

S141. Ans.(c)

Sol.

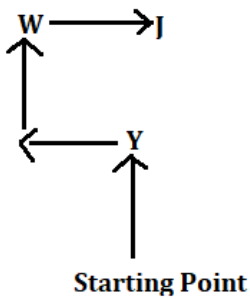

S142. Ans.(e)

Sol.

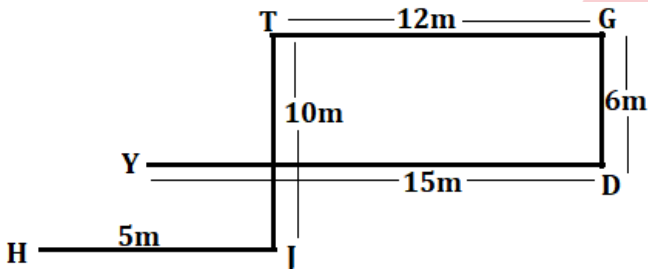

**Solution (143-145):**

Sol.

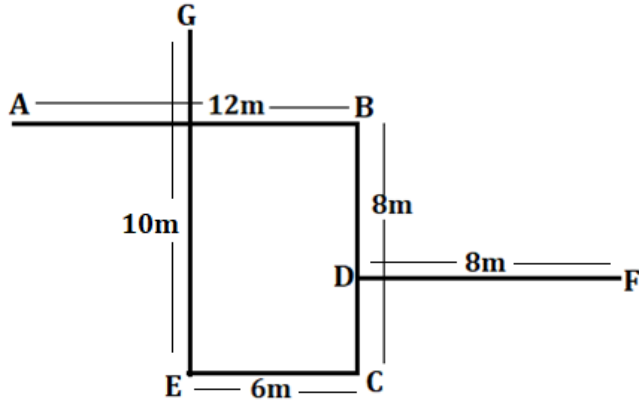

- S143. Ans.(a)
- S144. Ans.(e)
- S145. Ans.(b)

**Solutions (146-150):**

Sol.

Word	Code
The	mn
And	pq
Logo	as
Registered	bn
Corporate	cd
Logitech	yi
Trademark	st

- S146. Ans.(c)
- S147. Ans.(e)
- S148. Ans.(e)
- S149. Ans.(e)
- S150. Ans.(d)

**Solutions (151-155):**

Given series - © MK1 & NY6 C = 4 W Ω BTU 2 3 AR E 0 β G + SX5 @ BO8V ^ % HL9  
**Step I:** © MK1 NY6 C = 4 W Ω BTU 2 @ β & 3 ARE 0 G + SX5 BO8V ^ % HL9  
**Step II:** © MKNYC = 4 W Ω BTU 2 @ β & 3 ARE G + SX8 6 5 1 0 BOV ^ % HL9  
**Step III:** © MKNYC = 4 W Ω BT 2 @ β & 3 ARE GXU L + S 8 6 5 1 0 BOV ^ % H 9

- S151. Ans.(a)
- S152. Ans.(e)
- S153. Ans.(b)
- S154. Ans.(b)
- S155. Ans.(a)

**Solution (156-158):**

Sol. By applying the given conditions on words and numbers we can find out our output.

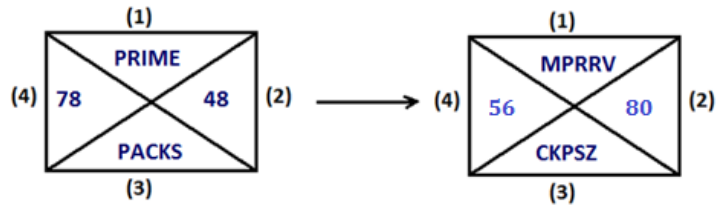

- S156. Ans.(b)
- S157. Ans.(d)
- S158. Ans.(c)

S159. Ans.(c)

Sol. S C R A B B L E  
 R B Q B A A K F  
 A A B B F K Q R

There are 14 letters between 'B' and 'Q'.

S160. Ans.(d)

Sol.



Solutions (161-163):

Sol. P (80) > R > T > Q (40) > U > S

S161. Ans.(c)

S162. Ans.(d)

S163. Ans.(b)

Solutions (164-166):

Sol.

Word	Code
Pictures	xl
And	sa
States	hx
Gates	zh
News	da
Upgrade	dx
In	fa
Standard	ha

S164. Ans.(b)

S165. Ans.(a)

S166. Ans.(c)

S167. Ans.(e)

Sol. Original number- 56298761

Obtained number- 12566789

S168. Ans.(d)

Sol.



S169. Ans.(e)

Sol. Number of students in the class= 28+17-1=44

S170. Ans.(d)

Sol. Original number- 56289174

Obtained number-74467356

Solutions (171-175):

Sol.

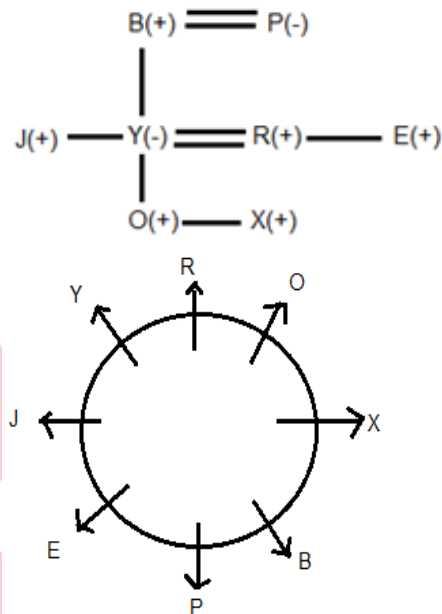

S171. Ans.(c)

S172. Ans.(a)

S173. Ans.(e)

S174. Ans.(b)

S175. Ans.(e)

Solutions (176-180):

Sol.

Word	Code
Around	fm
Plastic	pz
Shape	fe
Lost	mx
Feature	xe
Heavy	kx
Smog	xi
Phone/ Export	hb/yz

S176. Ans.(d)

S177. Ans.(c)

S178. Ans.(d)

S179. Ans.(b)

S180. Ans.(d)



**Solutions (181-185):**

S181. Ans.(b)

Sol.

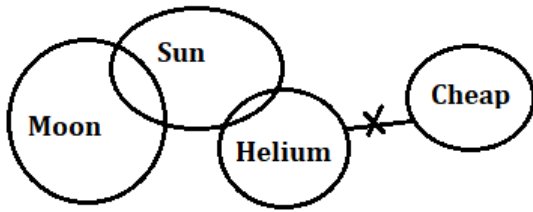

S182. Ans.(b)

Sol.

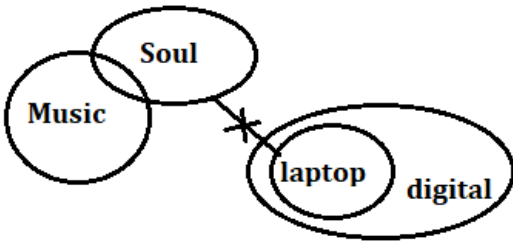

S183. Ans.(a)

Sol.

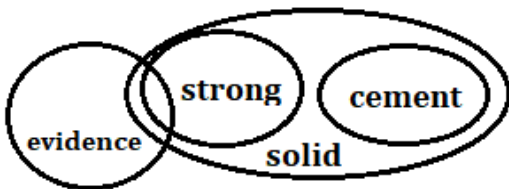

S184. Ans.(c)

Sol.

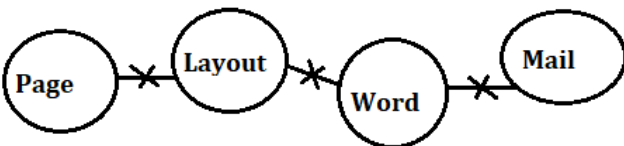

S185. Ans.(e)

Sol.

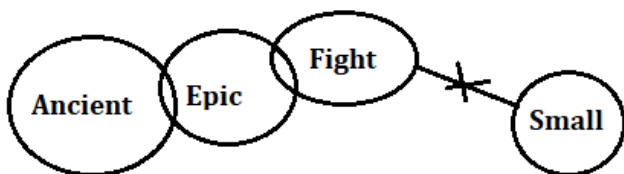

**Solutions (186-188):**

Sol. U>Q>S>T>P (15)>R

S186. Ans.(e)

S187. Ans.(b)

S188. Ans.(e)

**Solutions (189-190):**

S189. Ans.(a)

Sol.

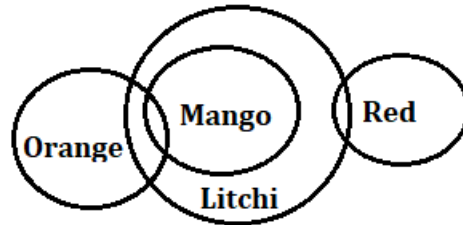

S190. Ans.(b)

Sol.

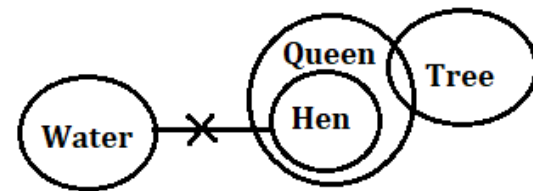

**Solutions (191-195):**

Sol.

BOX	Numbers of flower
A	32
D	14/9
F	9/14
G	16
B	40
E	17
C	25

S191. Ans.(c)

S192. Ans.(b)

S193. Ans.(c)

S194. Ans.(e)

S195. Ans.(e)

**Solutions (196-198):**

Sol.

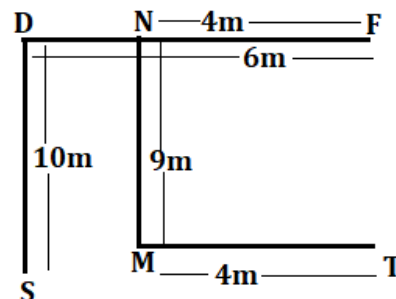

S196. Ans.(d)

S197. Ans.(d)

S198. Ans.(b)

**Solutions (199-200):**

Sol.

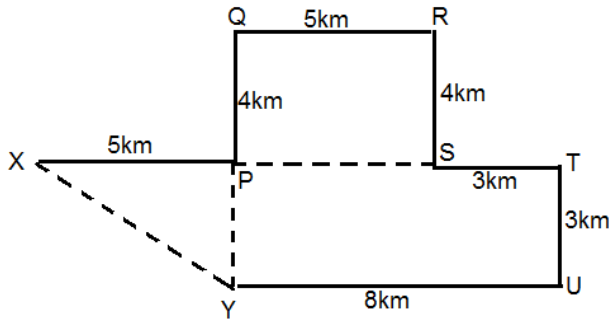

S199. Ans.(d)

S200. Ans.(a)

**Solutions (201-205):**

Sol.

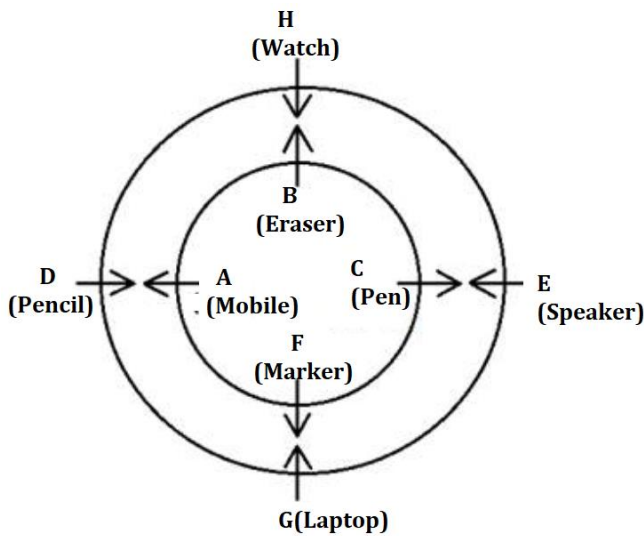

S201. Ans.(a)

S202. Ans.(b)

S203. Ans.(c)

S204. Ans.(d)

S205. Ans.(a)

**Solutions (206-210):**

Sol.

Word	Code
Casual	jk
Light	rm
Bottle	tr
Volume	lr
Product	sv
Report	mo

S206. Ans.(d)

S207. Ans.(c)

S208. Ans.(b)

S209. Ans.(b)

S210. Ans.(a)

**Solutions (211-213):**

Sol.

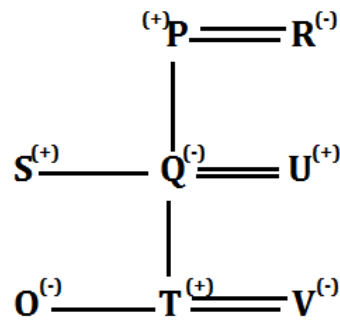

S211. Ans.(b)

S212. Ans.(d)

S213. Ans.(c)

S214. Ans.(a)

Sol.

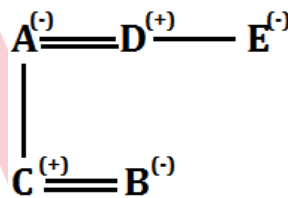

S215. Ans.(b)

Sol.

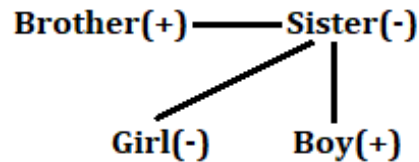

**Solutions (216-220):**

S216. Ans.(c)

Sol. Series = A B B C D E F E I B C A F E C B B A C A O B  
N U V W

S217. Ans.(a)

Sol. New Series = B B C D F B C F C B B C B N V W

S218. Ans.(e)

Sol. Series = A B B C D E F E I B C A F E C B B A C A O B  
N U V W

S219. Ans.(b)

Sol. 7<sup>th</sup> to the right of 10<sup>th</sup> alphabet from right = 3<sup>rd</sup> from right

New Series = E C B B A C A O B N U V W A B B C D E F E  
I B C A F

S220. Ans.(b)

Sol. Series = A B B C D E F E I B C A F E C B B A C A O B  
N U V W

**Solutions (221-225):**

**Sol.**

Floors	Persons	Sports
8	Y	Kabaddi
7	X	Boxing
6	W	Hockey
5	V	Cricket
4	U	Archery
3	T	Chess
2	S	Tennis
1	R	Football

S221. Ans.(a)

S222. Ans.(d)

S223. Ans.(e)

S224. Ans.(c)

S225. Ans.(d)

**Solutions (226-230):**

S226. Ans.(a)

**Sol.** the train leaves at !@ i.e. 1:25, reaches after 4 hours then the train reaches at 5:25 i.e. @@

S227. Ans.(d)

**Sol.** #& i.e. 8:20. Usually she arrives 15min before, means at 8:05 or #!. It takes her 4 hrs. 5 min to reach home from office, therefore she left office at &% i.e., 4:00.

S228. Ans.(e)

**Sol.** To calculate the charge paid, distance is required which will be calculated by time and speed. But here only time is known but speed is not given.

S229. Ans.(a)

**Sol.** Arun usually reaches office at \$! or 10:05 but today got delayed by 15 min. Therefore, he reaches office at 10:20 i.e., \$&

S230. Ans.(d)

**Sol.** Bus starts at @# i.e., 5:40 and reaches Delhi at #& i.e., 8:20, so the total time taken is 2hrs. 40 min or 8/3 hrs. Therefore, the speed of the bus is 56km / (8/3 hr.) = 21km/ hrs.

**Solutions (231-235):**

**Sol.**

Floor	Persons	Places
5	D	Mumbai
4	F	Vadodara
3	B	Gandhinagar
2	C	Surat
1	E	Ahmedabad
0	A	Pune

S231. Ans.(e)

S232. Ans.(a)

S233. Ans.(b)

S234. Ans.(d)

S235. Ans.(d)

**Solutions (236-240):**

**Sol.**

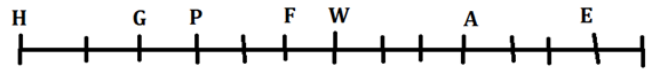

S236. Ans.(d)

S237. Ans.(e)

S238. Ans.(a)

S239. Ans.(c)

S240. Ans.(b)

**Solutions (241-244):**

S241. Ans.(c)

**Sol.** From either statement I or II we get, "chess most success" is coded as "pq, ab, lm". Hence, the data either in statement I alone or in statement II alone are sufficient to answer the question.

S242. Ans.(c)

**Sol.** From statement I alone:

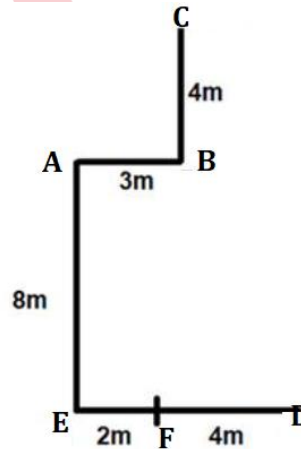

From statement II alone:

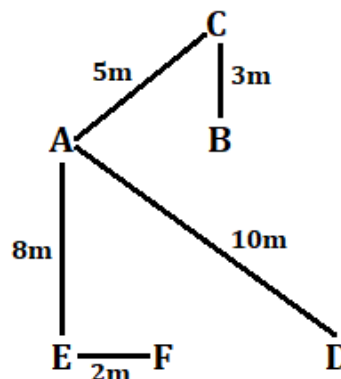

Hence, from either statement I or II alone, we can get the direction of F with respect to B.

**S243. Ans.(d)**

**Sol.** From the given statements we can't determine the answer. Hence, the data given in statements I and II together are not sufficient to answer the question.

**S244. Ans.(e)**

**Sol.** From statement I and II together:

Floors	Persons
7	C
6	A
5	F
4	B
3	E
2	G
1	D

Hence, the data in statements I and II together are necessary to answer the question.

**Solutions (245-248):**

**S245. Ans.(a)**

**Sol.** From statement I alone:

Floors	Persons
7	P
6	R
5	M
4	Q
3	N
2	L
1	O

Hence, the data in statement I alone are sufficient to answer the question, while the data in statement II alone are not sufficient to answer the question.

**S246. Ans.(b)**

**Sol.** From statement II alone:

The code for "Difficult examination pattern" is "opq stumno".

Hence, the data in statement II alone are sufficient to answer the question, while the data in statement I alone are not sufficient to answer the question.

**S247. Ans.(b)**

**Sol.** From statement II alone:  $X > S > U > T > W > Y/V > Y/V$

Hence, the data in statement II alone are sufficient to answer the question, while the data in statement I alone are not sufficient to answer the question.

**S248. Ans.(d)**

**Sol.** From the given statements we can't determine the answer. Hence, the data given in statements I and II together are not sufficient to answer the question.

**S249. Ans.(c)**

**Sol.** Given number - 36985247

After operation - 17793355

So, 3, 5 and 7 are the repeated numbers.

**S250. Ans.(c)**

**Sol.**



**Solutions (251-252):**

**Sol.**  $X > D > W > V (70\text{kg}) > L > N (58)$

**S251. Ans.(b)**

**S252. Ans.(d)**

**S253. Ans.(d)**

**Sol.** Number of boys who passed =  $(31 + 13 - 1) = 43$

$\therefore$  Total number of boys in the class =  $(43 + 6 + 4) = 53$

**S254. Ans.(b)**

**Sol.** Clearly, Aman is 10th from the right end and Babloo is 8th from the left end and 12th from the right end of the row

So, number of boys in the row =  $(8 - 1 + 12) = 19$

Now, Aman is 10th from the right

Aman from left end =  $19 - (10 - 1)$

Hence, Aman is 10th from the left end of the row.

**S255. Ans.(e)**

Harmaini position from right end =  $(37 + 1 - 19) = 19$

Students between them =  $(19 - 16 - 1) = 2$

**Solutions (256-260):**

**Sol.**

Box	Colour
O	Green
L	Grey
M	Blue
J	White
N	Black
K	Orange

**S256. Ans.(a)**

**S257. Ans.(c)**

**S258. Ans.(e)**

**S259. Ans.(b)**

**S260. Ans.(c)**

**Solutions (261-265):**

**S261. Ans.(b)**

**Sol.** I.  $P > U$  (False)      II.  $N < H$  (True)

S262. Ans.(d)

Sol. I.  $V < D$  (False) II.  $H \leq V$  (False)

S263. Ans.(c)

Sol. I.  $J > H$  (False) II.  $J = H$  (False)

S264. Ans.(d)

Sol. I.  $W > M$  (False) II.  $Q \leq K$  (False)

S265. Ans.(e)

Sol. I.  $O < C$  (True) II.  $B > L$  (True)

S266. Ans.(e)

Sol.  
MAJOR  
XIX  
BNKSP

S267. Ans.(c)

Sol.  
ARCHEOLOGY

S268. Ans.(e)

Sol. After interchanging the positions -  
I. RENIRMTETE - RETIREMENT  
II. ADOTRNTIAA - RDATAATION  
III. LNOUINTISA - INSULATION

S269. Ans.(a)

Sol. After operation -  
I. PERFORM - DNGNQSS  
II. REVENUE - DDDTOSW  
III. EMPLOY - DNMNQZ  
So, QON is the correct answer.

S270. Ans.(a)

Sol. Given word - DELIBRATELY  
After operation - ABDEILLRTY  
Hence, Y will remain unchanged.

**Solutions (271-275):**

S271. Ans.(a)

Sol. I.  $B < E$  (true) II.  $F > A$  (false)

S272. Ans.(d)

Sol. I.  $O \geq L$  (false) II.  $K \geq O$  (false)

S273. Ans.(c)

Sol. I.  $N > X$  (false) II.  $N \leq S$  (false)

S274. Ans.(b)

Sol. I.  $X > U$  (false) II.  $P \leq R$  (true)

S275. Ans.(b)

Sol. I.  $O \geq I$  (false) II.  $R < Y$  (true)

**Solutions (276-280):**

S276. Ans.(e)

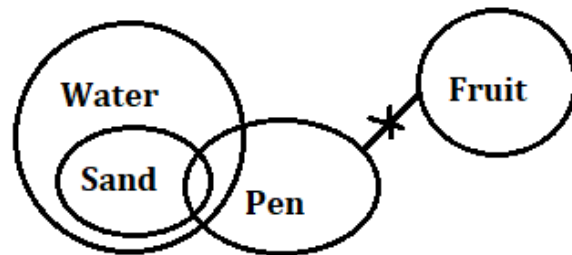

S277. Ans.(d)

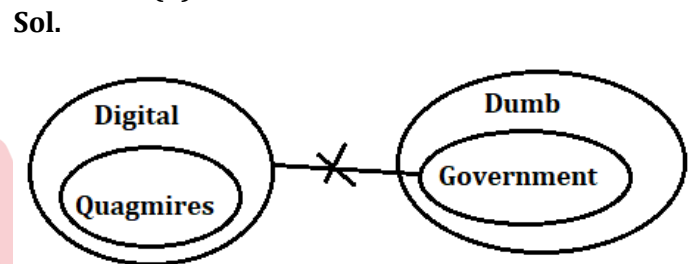

S278. Ans.(d)

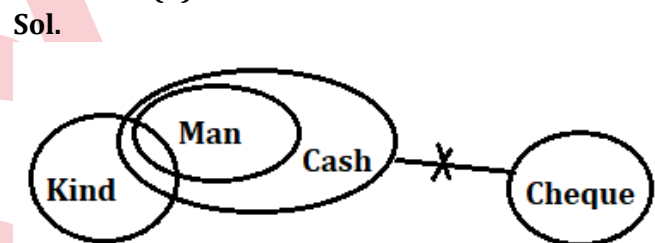

S279. Ans.(c)

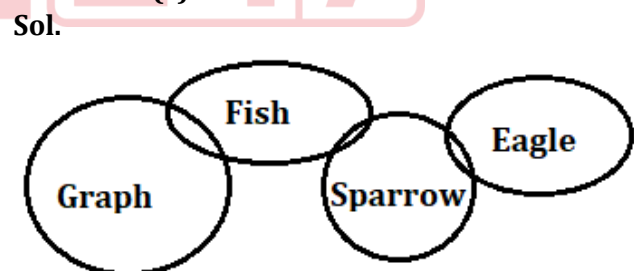

S280. Ans.(d)

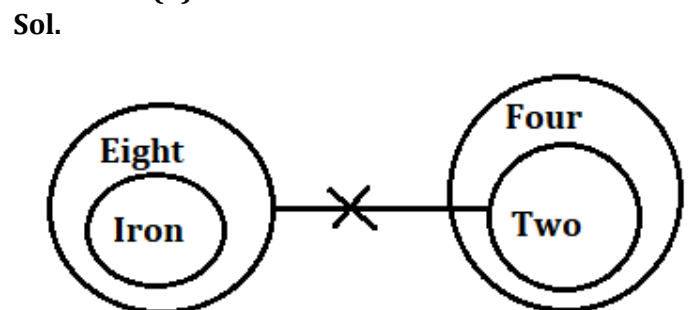

**Solutions (281-285):**

Sol.

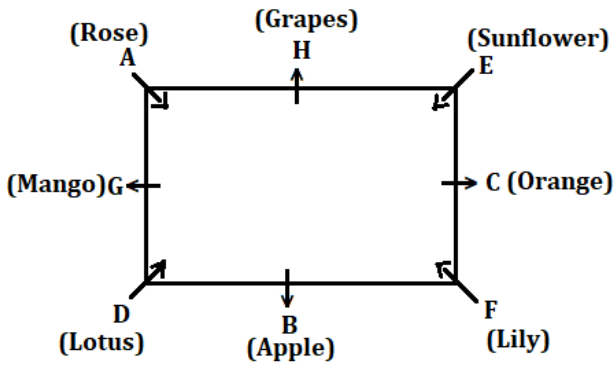

- S281. Ans.(b)
- S282. Ans.(c)
- S283. Ans.(a)
- S284. Ans.(c)
- S285. Ans.(b)

**Solutions (286-290)**

Sol.

Floor	Person	Car
7	T	Volvo
6	P	Honda
5	R	Toyota
4	U	Kia
3	Vacant	floor
2	S	Maruti
1	Q	BMW

- S286. Ans.(b)
- S287. Ans.(e)
- S288. Ans.(c)
- S289. Ans.(a)
- S290. Ans.(d)

**Solutions (291-295):**

Sol.

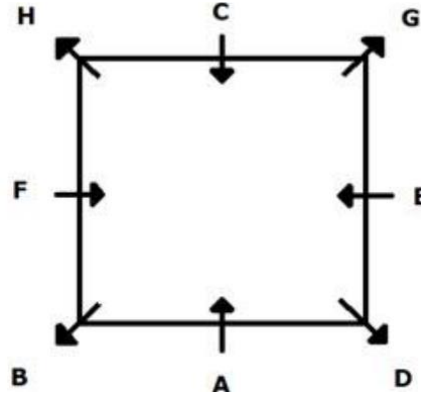

- S291. Ans.(a)
- S292. Ans.(a)
- S293. Ans.(c)
- S294. Ans.(b)
- S295. Ans.(b)
- S296. Ans.(e)
- S297. Ans.(d)
- S298. Ans.(e)
- S299. Ans.(a)
- S300. Ans.(e)

ENGLISH

# MAESTRO

## RBI GRADE 'B' PHASE-I + II

200+ TOTAL TESTS