

All India Maha Mock: FCI AGM 15th May 2021 (Solutions)

Solutions (1-5): From the given statements, first we find out the blood relation:

P who is father of R sits third to the right of Q's daughter-in-law. W sits at the immediate left of Q's father-in-law who is married with V. P is the only child of V who sits opposite to the one who sits at the immediate left of R's wife.

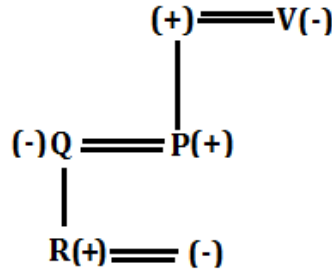

X is son of U who is a female member. S is paternal aunt of X and sits second to the right of Q's only sibling which means Q has either brother or sister. W sits only with Y who is child of U. Y is not nephew of S which means Y is niece of S.

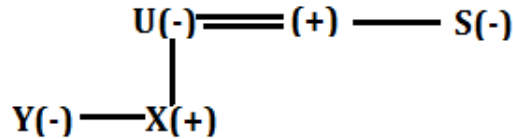

R has more than one child. W is not married which means W is sibling of Q and R is husband of U and T is husband of V. So, the final arrangement is :

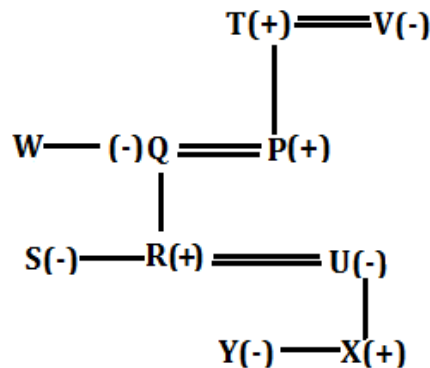

For sitting arrangement:

From the given statements, W sits only with Y who is child of U. W is not married and sits opposite to R. S is paternal aunt of X and sits second to the right of Q's only sibling. W sits at the immediate left of Q's father in law who is married with V. R's spouse sits on the same side with R.

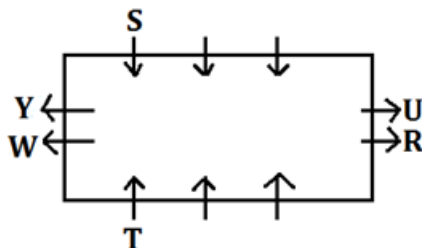

NRA-CET Ready

BANK MAHA PACK

Live Class, Video Course,
Test Series, eBooks

Bilingual (with eBooks)
12+12 Months Validity

P who is father of R sits third to the right of Q's daughter-in-law. P is the only child of V who sits opposite to the one who sits at the immediate left of R's wife.

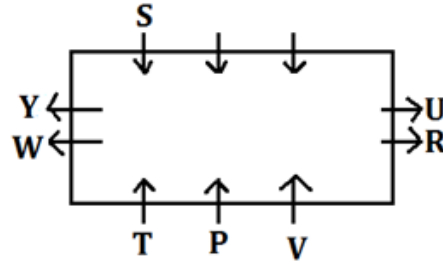

P's wife sits at the immediate left of Y sibling. So, the final arrangement is :

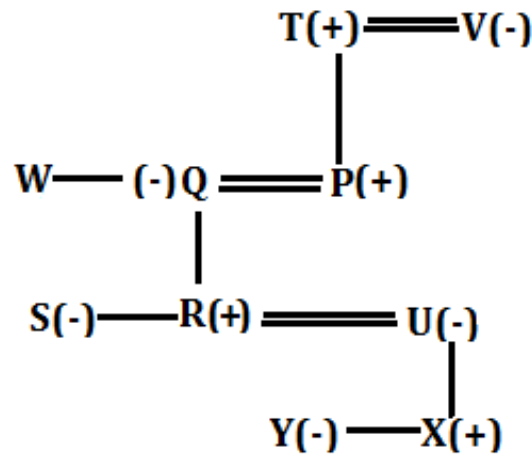
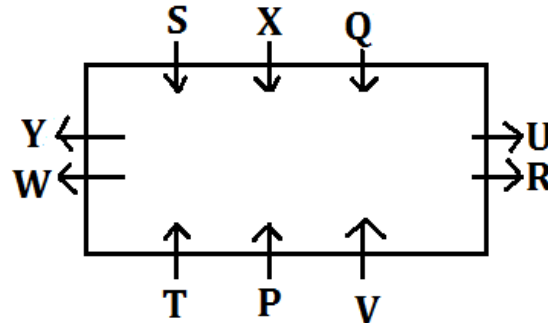

S1. Ans.(d)

S2. Ans.(c)

Sol. Except U all are males.

S3. Ans.(e)

S4. Ans.(b)

S5. Ans.(a)

Solutions (6-10): Logic:

Step I: The words are arranged in reverse alphabetical order and the vowels (within the words) are written in small letters.

Step II: - If the word starts with a consonant, then the first digit shows the total number of consonants and second digit shows the total number of vowels (with in the given word).

If the word starts with a vowel, then the first digit shows the total number of vowels and second digit shows the total number of consonants (with in the given words).

Step III: Subtract 11 from each of the number.

Step IV: Sum of the digits with in the given number is taken.

Step V: Arrange the numbers in ascending order from left to right.

Input:	FLOATING	PROPERTY	INVASION	MASSIVE	AUTHORITY
Step I:	PRoPeRTY	MaSSiVe	iNVaSiON	FLoaTiNG	auTHoRiT <small>Y</small>
Step II :	62	43	44	53	45
Step III:	51	32	33	42	34
Step IV:	06	05	06	06	07
Step V:	05	06	06	06	07

S6. Ans.(b)

S7. Ans.(d)

S8. Ans.(a)

S9. Ans.(c)

S10. Ans.(e)

Sol. I (J, K, L, M) N

S11. Ans.(a)

Sol.

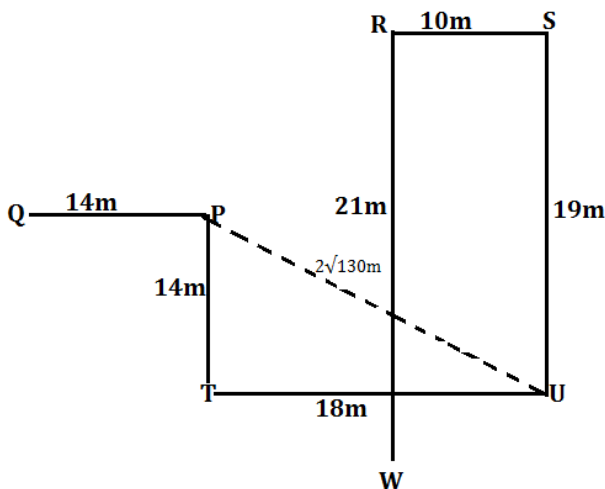

S12. Ans.(a)

Sol.

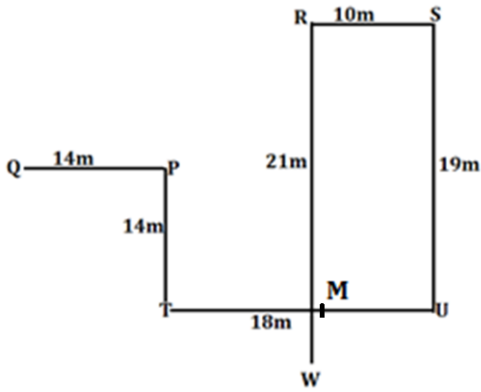

S13. Ans.(d)

Sol.

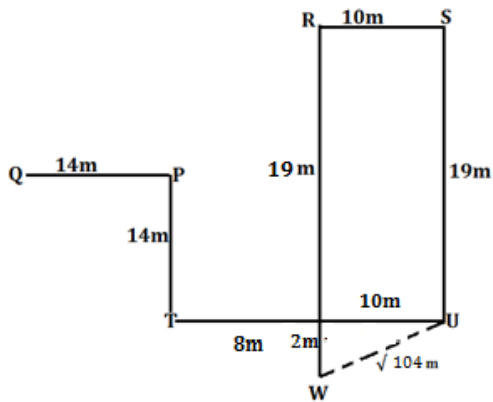

Solutions (14-16): From the given statements, the distance between the P2 and P6 is 135m. P4 is planted to the right of P2. P6 is planted to the right of P4. The distance between the P6 and P7 is same as that of P2 and P6. P7 is planted just next to the P3.

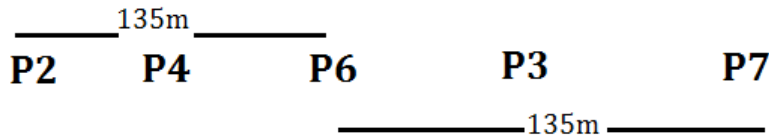

Not more than two plants are planted to the right of P6. The distance between P1 and P4 is 45m which means P1 is either between P2 and P4 or between P4 and P6. So, we have two possible cases:

Case 1:

Case 2:



Only two plants are planted between P5 and P4. So, case 1 gets eliminated here and the final arrangement is:

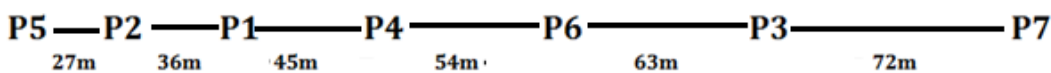

S14. Ans.(a)

S15. Ans.(d)

S16. Ans.(c)

S17. Ans.(e)

Sol. By combing both I and II, we get to know that box G is placed just above the box B.

Boxes

G
B
D

S18. Ans.(b)

Sol. Only from II, we get to know that Q lives on the 3rd floor.

Floor	Persons
7	R
6	T
5	V/P
4	P/V
3	Q
2	S
1	U

S19. Ans.(c)

Sol. From I. E sits 2nd to the left of D.

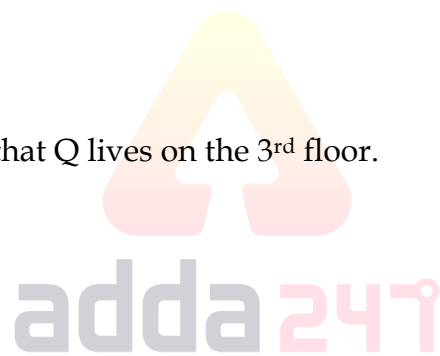
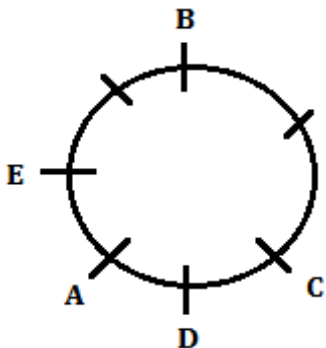

From II. A sits 2nd to the left of D.

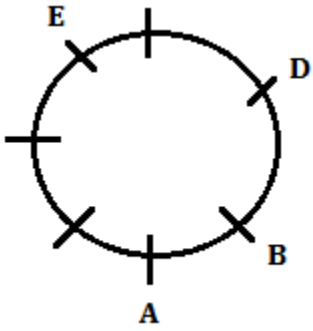

S20. Ans.(e)

Sol. By combining both I and II we get the code for "parrot" i.e. "mr".

Words	Codes
certain	mn
rail	dk
track	sl
drive	pv
parrot	mr
prison	ns

S21. Ans.(b)

Sol. Cost price of article A = $720 \times \frac{100}{120} = 600$ Rs.

Cost price of article D = $1500 \times \frac{100}{125} = 1200$ Rs

Selling price of article, A = $720 \times \frac{8}{9} = 640$ Rs

Selling price of article, D = $1500 \times \frac{14}{15} = 1400$ Rs

Profit on article A = $640 - 600 = 40$ Rs.

Profit on article D = $1400 - 1200 = 200$ Rs

Required ratio = $\frac{40}{200} = 1 : 5$

S22. Ans.(a)

Sol. Cost price of E = $500 \times \frac{100}{125} \times \frac{150}{100} = 600$ Rs.

For $16\frac{2}{3}\%$ profit article E sold on = $600 \times \frac{7}{6} = 700$ Rs.

S23. Ans.(e)

Sol. Cost price of article B = $500 \times \frac{100}{125} = 400$

And, cost price of article D = $1500 \times \frac{100}{125} = 1200$ Rs.

Let discount allowed on B = X%

And, discount allowed in D = 3X%

And, ratio of profit on article B & loss on article D = 1 : 1

ATQ -

$$\frac{[500 - (500 \times \frac{X}{100})] - 400}{1200 - [1500 - (1500 \times \frac{3X}{100})]} = \frac{1}{1}$$

$$(500 - 5X) - 400 = 1200 - (1500 - 45X)$$

$$100 - 5X = -300 + 45X$$

$$50X = 400$$

$$X = 8\%$$

Discount allowed on article D = $3 \times 8 = 24\%$

S24. Ans.(d)

Sol. Cost price of article A = $720 \times \frac{100}{120} = 600$ Rs.

Cost price of article B = $500 \times \frac{100}{125} = 400$ Rs

Cost price of article C = $1040 \times \frac{100}{130} = 800$ Rs

Cost price of article D = $1500 \times \frac{100}{125} = 1200$ Rs.

average cost price of B, C & D = $\frac{400+800+1200}{3} = 800$ Rs.

Required percentage = $\frac{800 - 600}{800} \times 100$

$$= \frac{200}{800} \times 100 = 25\%$$

S25. Ans.(d)

Sol. Selling price of article C = $1040 \times \frac{85}{100} = 884$ Rs

Selling price of article X = $884 + 316 = 1200$ Rs.

Cost price of article X = $1200 \times \frac{100}{120} = 1000$ Rs.

Cost price of article D = $1500 \times \frac{100}{125} = 1200$ Rs.

Required difference = $1200 - 1000 = 200$ Rs.

S26. Ans.(c)

Sol. From I -

Let income of Sameer = $25x$

So, income of Veer = $25x \times \frac{96}{100} = 24x$

Let expenditure of Veer = $7y$

So, expenditure of Sameer = $8y$

Deepak spend $\frac{3}{5}$ th of his income.

From II -

Saving of Sameer = 7000 Rs.

Saving of Veer = 7400

And, Income of Deepak is Rs. 1000 more than that of Sameer

From I & II -

$$\frac{(25x-7000)}{(24x-7400)} = \frac{8y}{7y}$$

$$17x = 10200$$

$$x = 600 \text{ Rs.}$$

$$\text{Income of Deepak} = 25 \times 600 + 1000 = 16000 \text{ Rs.}$$

$$\text{Saving of Deepak} = \frac{2}{5} \times 16000 = 6400 \text{ Rs.}$$

$$\text{Respective ratio of saving of Veer \& Deepak} = 7400 : 6400 = 37 : 32$$

So, Statement I & II together is sufficient to give answer of the question.

S27. Ans.(b)

$$\text{Sol. Let cost price} = 100x$$

$$\text{Marked price} = 140x$$

From I -

$$140x \times \frac{75}{100} - 100x = 50$$

$$5x = 50$$

$$x = 10 \text{ Rs.}$$

$$\text{Cost price} = 1000 \text{ Rs.}$$

Statement I alone is sufficient.

From II -

$$(140x \times \frac{6}{7} \times \frac{90}{100}) - 100x = 80$$

$$8x = 80$$

$$x = 10 \text{ Rs.}$$

$$\text{Cost price} = 1000 \text{ Rs.}$$

Statement II alone is sufficient.

So, either statement I or II alone is sufficient to give answer of the question.

S28. Ans.(a)

$$\text{Sol. Given, number of green balls} = 5$$

$$\text{So, let total number of blue balls} = x$$

$$\text{So, number of red balls} = (7 - x)$$

From I -

$$\frac{x}{12} + \frac{7-x}{12} = \frac{7}{12}$$

So, we can't determine value of x from statement I

From II -

$$\frac{x(x-1)}{12 \times 11} + \frac{(7-x)(6-x)}{12 \times 11} = \frac{1}{6}$$

$$2x^2 - 14x + 42 = 22$$

$$2x^2 - 14x + 20 = 0$$

$$2x^2 - 10x - 4x + 20 = 0$$

$$2x(x-5) - 4(x-5) = 0$$

$$x = 2, 5$$

From II alone we can determine the difference between blue & red balls in the bag.

So, only statement II alone is sufficient to give answer of the question.

S29. Ans.(b)**Sol.** Let radius of circle = r cmSo, side of square = $r + 3.5$ cm**From I -**

$$2 \times \frac{22}{7} \times r - 2r = 45$$

$$r = 10.5 \text{ cm}$$

side of square = $10.5 + 3.5 = 14$ cmArea of square = 196 cm^2

Statement I alone is sufficient to give answer.

From II -Let breadth of rectangle = $2x$ So, radius of circle will be = $3x$

ATQ -

$$\frac{2 \times \frac{22}{7} \times 3x}{2(2x+15)} = \frac{3}{2}$$

$$x = 3.5 \text{ cm}$$

Radius of circle = 10.5 cmside of square = $10.5 + 3.5 = 14$ cmArea of square = 196 cm^2

So, either statement I or Statement II alone is sufficient.

S30. Ans.(e)**Sol. From I -**Difference between speed of train A & B = 10 meters/secAnd, length of train B = 240 meters

From I, we can't determine

From II -Train B cross pole in 8 secAnd train B cross train A in 12 sec

From II, we can't determine

From I & II -

$$\text{Speed of train B} = \frac{240}{8} = 30 \text{ meters/sec}$$

$$\text{Speed of train A} = 30 - 10 = 20 \text{ meters/sec}$$

Let length of train A = L meters

$$\text{So, } (30 + 20) = \frac{240+L}{12}$$

$$L = 600 - 240$$

$$L = 360 \text{ meters}$$

So, Statement I and II both together sufficient to give answer of the questions

S31. Ans.(b)**Sol.** Let efficiency of Y = 5w units/daySo, efficiency of X = $5w \times \frac{140}{100} = 7w$ units/dayGiven, time taken by Z to complete the work is $\frac{2}{3}$ rd of the time taken by X.So, efficiency of Z = $7w \times \frac{3}{2} = \frac{21w}{2}$ units/dayOne day work of X, Y & Z together = $(5w + 7w + \frac{21w}{2}) = \frac{45w}{2}$ unitsTotal work = $\frac{45w}{2} \times \frac{56}{9} = 140w$ units

Two times of work = 280w units

Required days = $\frac{280w \times 2}{35w} = 16$ days**S32. Ans.(a)****Sol.** Let speed of A & B be 6s m/sec & 7s m/sec respectivelySo, $7s - 6s = \frac{10}{3}$ $s = \frac{10}{3}$ m/sSpeed of train A = $6 \times \frac{10}{3} = 20$ m/sAnd, speed of train B = $7 \times \frac{10}{3} = \frac{70}{3}$ m/s

Let length of train A & B be x meter & y meter respectively

ATQ -

$$\frac{13(x+y)}{120} = \frac{130}{3}$$

$$x + y = 400 \text{ meters}$$

Now, length of platform = 2x

$$\frac{x+2x}{24} = 20$$

$$x = 160 \text{ meters}$$

So, length of train B = $400 - 160 = 240$ meters**S33. Ans.(e)****Sol.** Let investment of A & C be 4x & 3x respectivelyAnd investment of B = $(2400 - 7x)$

Profit sharing ratio of A, B & C

$$= 4x \times 15 : (2400 - 7x) \times 18 : 3x \times 24$$

$$= 20x : (14400 - 42x) : 24x$$

ATQ -

$$\frac{20x}{(14400-42x)} = \frac{10}{15}$$

$$30x = 14400 - 42x$$

$$72x = 14400$$

$$x = 200 \text{ Rs.}$$

$$\text{Investment of B} = 2400 - 7 \times 200 = \text{Rs. } 1000$$

$$\text{Investment of C} = 3 \times 200 = 600 \text{ Rs.}$$

$$\text{Required difference} = 1000 - 600 = 400 \text{ Rs.}$$

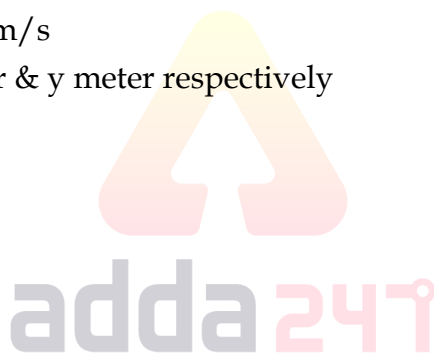

TEST SERIES

Bilingual

SBI CLERK 2021

100+ TOTAL TESTS

S34. Ans.(b)

Sol. Let still water speed of boat A is x km/hr

So, speed of boat B in still water = $(64 - x)$ km/hr

ATQ—

$$\frac{240}{(64 - x - 4)} = \frac{240}{(x + 4)}$$

$$\frac{240}{(60 - x)} = \frac{240}{(x + 4)}$$

$$x + 4 = 60 - x$$

$$2x = 56$$

$$x = 28 \text{ km/hr}$$

speed of boat B in still water = $(64 - 28) = 36$ km/hr

S35. Ans.(b)

Sol. ATQ,

Ram's age = $29 + 5 = 34$ years

$$\Rightarrow 3x + 2y = 34 \quad \text{—————(1)}$$

$$\text{Also, } x - y = 3 \quad \text{—————(2)}$$

Solving (1) & (2),

$$x = 8, y = 5$$

$$\text{required average age} = \frac{34+29+8+5}{4} = 19 \text{ years}$$

**S36. Ans.(c)**

Sol. Given, sprite taken out from glass 'A' = $4X$ ml

Total mixture in glass 'B' = $(220 + 4X)$ ml

$$\text{Ratio of coke to sprite in glass 'B'} = \frac{220}{4X} = \frac{55}{X}$$

Now mixture taken out from glass 'B' and poured in glass 'C' = $3X$ ml

Given, ratio of coke to sprite in glass 'C' = $11 : 4$

$$\frac{3X}{55 + X} \times 55 : \frac{3X}{55 + X} \times X = 11 : 4$$

$$\frac{55}{X} = \frac{11}{4}$$

$$X = 20 \text{ ml}$$

$$\text{Required quantity} = 4 \times X - \frac{3X}{55 + X} \times X$$

$$= 4 \times 20 - \frac{3 \times 20}{55 + 20} \times 20$$

$$= 80 - \frac{60}{75} \times 20$$

$$= 80 - 16 = 64 \text{ ml}$$

S37. Ans.(d)**Sol.** Let radius of cylinder = r cm

And, let height of cylinder = h cm

ATQ -

$$2r = \frac{2}{3} (r + h)$$

$$3r = r + h$$

$$h = 2r$$

Curved surface area of cylinder = $2\pi rh$ And, volume of cylinder = $\pi r^2 h$

$$\frac{2\pi rh}{\pi r^2 h} = \frac{1}{7}$$

$$r = 14 \text{ cm}$$

$$h = 28 \text{ cm}$$

$$\text{So, } l = \sqrt{r^2 + h^2}$$

$$l = \sqrt{14^2 + 28^2}$$

$$l = \sqrt{196 + 784}$$

$$l = \sqrt{980}$$

$$l = \sqrt{7 \times 7 \times 2 \times 2 \times 5}$$

$$l = 14\sqrt{5} \text{ cm}$$

S38. Ans.(b)**Sol.** Let saving of A, B & C be Rs. X, Rs. Y & Rs. Z respectively

ATQ -

Equivalent CI of two years at the rate of 20% = $20 + 20 + \frac{20 \times 20}{100} = 44\%$

$$\frac{44}{100} (X + Y + Z) = 1694$$

$$X + Y + Z = 1694 \times \frac{100}{44}$$

$$X + Y + Z = 3850 \text{ ----- (i)}$$

And, when A & C invested double of their respective saving -

$$\frac{20}{100} \times (2X + 2Z) = 1100$$

$$X + Z = 2750 \text{ ----- (ii)}$$

Saving of B = $3850 - 2750 = 1100$ Rs.Required difference = $2750 - 1100 = 1650$ Rs.**S39. Ans.(a)****Sol.** Let cost price of shirt = X Rs.So, cost price of jeans = $(X + 200)$ Rs.Selling price of shirt = $\frac{4X}{5} = 0.80X$ Rs.Selling price of jeans = $(X + 200) \times \frac{5}{4} = (1.25X + 250)$ Rs.

ATQ -

$$2X + 200 = (2.05X + 250) \times \frac{700}{740}$$

$$74X + 7400 = 71.75X + 8750$$

$$2.25X = 1350$$

$$X = 600 \text{ Rs.}$$

Cost price of jeans = 800 Rs.

$$\text{Now, SP of shirt when shirt sold at 25\% profit} = 600 \times \frac{125}{100} = 750 \text{ Rs.}$$

$$\text{And, SP of jeans when jeans sold at 20\% loss} = 800 \times \frac{80}{100} = 640 \text{ Rs.}$$

Total selling price = 750 + 640 = 1390 Rs.

$$\text{Required loss \%} = \frac{1400 - 1390}{1400} \times 100 = \frac{10}{14} \% = \frac{5}{7} \%$$

S40. Ans.(c)

Sol. Let total number of red balls = x

So, total number of blue balls = $(12 - x)$

ATQ -

$$\frac{x(12-x)}{6 \times 11} = \frac{35}{66}$$

$$12x - x^2 = 35$$

$$x^2 - 12x + 35 = 0$$

$$x(x - 5) - 7(x - 5) = 0$$

$$x = 5 \text{ \& } 7$$

Now new number of blue balls in bag = $(7 + n)$

$$\text{Given, } \frac{(5+n)}{(10+n)} = \frac{9}{14}$$

$$70 + 14n = 90 + 9n$$

$$5n = 20$$

$$n = 4$$

S41. Ans.(a)

Sol. Let total students from A = $100a$

And, let total students from E = $100b$

ATQ -

Total passed students in A = $60a$

$$60a \times \frac{7}{12} - 60a \times \frac{5}{12} = 80$$

$$35a - 25a = 80$$

$$10a = 80$$

$$a = 8$$

$$\text{Total failed girls from A} = 800 \times \frac{40}{100} \times \frac{3}{8} = 120$$

Total passed students from E = $75b$

$$75b \times \frac{8}{15} - 75b \times \frac{7}{15} = 50$$

$$40b - 35b = 50$$

$$5b = 50$$

$$b = 10$$

$$\text{Total failed girls from E} = 1000 \times \frac{25}{100} \times \frac{2}{5} = 100$$

$$\text{Required sum} = 120 + 100 = 220$$

S42. Ans.(c)

Sol. Let total students from B = x

And, let total students from C = y

ATQ -

$$x \times \frac{30}{100} : y \times \frac{35}{100} = 9 : 7$$

$$x = 1.5y$$

$$\text{Given, } 1.5y \times \frac{70}{100} + y \times \frac{65}{100} = 1020$$

$$170y = 102000$$

$$y = 600$$

$$\text{And, } x = 1.5 \times 600 = 900$$

$$\text{Required sum} = 600 + 900 = 1500$$

S43. Ans.(e)

Sol. Let total students from D = 100x

So, total passed students from D = 80x

ATQ -

$$80x \times \frac{5}{8} - 80x \times \frac{3}{8} = 100$$

$$20x = 100$$

$$x = 5$$

$$\text{Total students from D} = 500$$

$$\text{Total failed students from E} = 500 \times \frac{20}{100} \times \frac{250}{100} = 250$$

$$\text{Total students from E} = 250 \times \frac{100}{25} = 1000$$

$$\text{Required ratio} = 500 : 1000 = 1 : 2$$

S44. Ans.(b)

Sol. Let total students from A = 100a

And, total passed students from A = 60a

ATQ -

$$\text{Total passed students from E} = 60a \times \frac{156.25}{100} = 93.75a$$

$$\text{Total students from E} = 93.75a \times \frac{100}{75} = 125a$$

$$\text{Total failed students from E} = 125a \times \frac{25}{100} = 31.25a$$

$$\text{Required percentage} = \frac{40a - 31.25a}{31.25a} \times 100$$

$$= \frac{8.75a}{31.25a} \times 100 = 28\%$$

TEST SERIES

ENGLISH



FCI 2021

**ASST. GENERAL MANAGER
(General Administration)**

20 TOTAL TESTS



S45. Ans.(c)

Sol. Let total students from A = 100a

So, total students from C = 75a

ATQ -

$$100a \times \frac{40}{100} + 75a \times \frac{35}{100} = 530$$

$$40a + 26.25a = 530$$

$$a = 8$$

$$\text{Total passed boys from A} = 800 \times \frac{60}{100} \times \frac{5}{12} = 200$$

$$\text{Total passed boys from C} = 75 \times 8 \times \frac{65}{100} \times \frac{6}{13} = 180$$

$$\text{Required average} = \frac{200 + 180}{2} = 190$$

S46. Ans.(c)

Sol. Max Life Insurance has launched 'Max Life Critical Illness and Disability Rider' and with it, the 'Max Fit', a comprehensive wellness programme. Max Fit is a wellness app designed to lead customers on a path of protection through holistic fitness and wellness.

S47. Ans.(a)

Sol. Lakshadweep is second only to Sikkim, which was India's first state to be declared completely organic. This comes after the UT received proper certifications and declarations under the Centre's Paramparagat Krishi Vikas Yojana (organic farming improvement programme).

S48. Ans.(a)

Sol. Assam, Poba Reserve Forest in Dhemaji district would be upgraded to a wildlife sanctuary.

S49. Ans.(b)

Sol. Bhogapuram Airport is a new international airport construction project for the Indian state of Andhra Pradesh.

S50. Ans.(e)

Sol. This year IMC's theme is going to be - "Inclusive Innovation - Smart I Secure I Sustainable"

S51. Ans.(e)

Sol. Pangong Tso or Pangong Lake is an endorheic lake spanning eastern Ladakh and West Tibet.

S52. Ans.(b)

Sol. ICICI Bank announced the launch of a new mobile application for authorised money changers to help customers of any bank get 'ICICI Bank Forex Prepaid Card' swiftly.

S53. Ans.(c)

Sol. IIFL Home Finance and Standard Chartered Bank have entered into a co-lending arrangement for extending credit to the MSME lo**Ans.**(loan against property).

S54. Ans.(c)

Sol. Tertiary Sector (Services sector) is the largest sector of India.

S55. Ans.(d)

Sol. The World Economic Forum (WEF) releases the Global Risks Report. This year it has published 16th edition of the report.

S56. Ans.(e)

Sol. Small Industries Development Bank of India (SIDBI) has charted a plan to promote micro-enterprises in 115 aspirational districts across the country to contribute to their development.

S57. Ans.(d)

Sol. Rome, capital of Italy. Rome is located in the central portion of the Italian peninsula, on the Tiber River.

S58. Ans.(e)

Sol. The Reserve Bank of India will be setting up its first Automated Banknote Processing Centre (ABPC) in Jaipur for storage, receipt and dispatch of currency notes. The decision was taken to effectively deal with the increasing circulation of banknotes.

S59. Ans.(e)

Sol. Bombay Stock Exchange (BSE) Ltd. has launched an electronic spot platform, "BSE E-Agricultural Markets Ltd (BEAM)", for agricultural commodities through its subsidiary BSE Investments Ltd.

S60. Ans.(b)

Sol. In economics, deflation is a decrease in the general price level of goods and services. Deflation occurs when the inflation rate falls below 0%. Inflation reduces the value of currency over time, but deflation increases it.

S61. Ans.(b)

Sol. The National Sample Survey Office (NSSO) headed by a Director General is responsible for conduct of large-scale sample surveys in diverse fields on All India basis. It comes under the jurisdiction of Ministry of Statistics and Programme Implementation.

S62. Ans.(a)

Sol. Abu Dhabi Grand Prix 2020 race was won by Max Verstappen.

S63. Ans.(a)

Sol. Vidyavachaspati Bannanje Govindacharya Ji will be remembered for his great contributions to literature. His passion towards Sanskrit and Kannada were admirable.

S64. Ans.(c)

Sol. Haldia is an industrial port city in Purba Medinipur in the Indian state of West Bengal.

S65. Ans.(d)

Sol. Indian Financial System Code (or more commonly known as IFSC code) is an 11-digit alpha-numeric code used to uniquely identify bank branches within the National Electronic Funds Transfer (NEFT) network by central bank.

S66. Ans.(b)

Sol. The 9th edition of Sustainable Mountain Development Summit (SMDS) held in Dehradun, Uttarakhand.

S67. Ans.(c)

Sol. Kolkata is known as the City of castles because of the number of buildings built by the British Raj during the 19th century.

S68. Ans.(c)

Sol. Export-Import Bank of India (Exim Bank), on behalf of the Government of India, has extended a Line of Credit (LOC) of \$448 million to the Government of Republic of Uzbekistan.

S69. Ans.(b)

Sol. Corporation Bank was a public-sector banking company headquartered in Mangalore, India.

S70. Ans.(b)

Sol. Commodity Money is a form of Money with an intrinsic value.

S71. Ans.(c)

Sol. Junior Asian champion Yash Vardhan of India won the 10m air rifle event at the 6th edition of the International Online Shooting Championship.

S72. Ans.(a)

Sol. Vijay Diwas is celebrated on December 16 every year to honour the victory of Indian armed forces over Pakistan in the 1971 war.

S73. Ans.(e)

Sol. Ghana's President Nana Akufo-Addo has been re-elected after contesting in a tightly contested election.

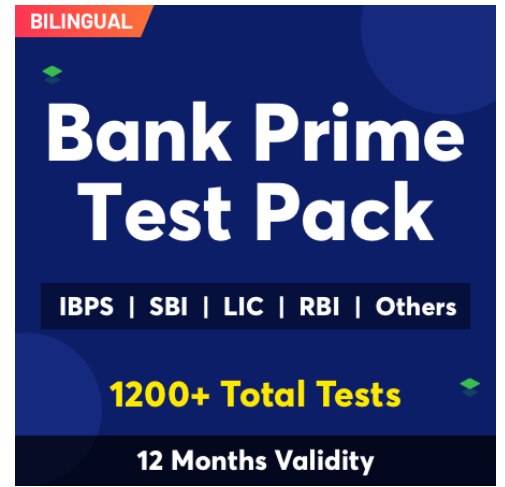

S74. Ans.(a)

Sol. BSE Ebix Insurance Broking, a joint venture of BSE and Ebix Fincorp Exchange, on Tuesday announced the beta launch of term insurance products on its platform. For this, BSE Ebix Insurance Broking has tied up with ICICI Prudential Life Insurance Co.

S75. Ans.(c)

Sol. The government has set a target of 175GW renewable energy capacity by the year 2022. Sector-wise, this bifurcates into 100GW from Solar energy, 60 GW from wind energy, 10GW from biopower and 5GW from hydropower.

S76. Ans.(d)

Sol. Global financial services major HSBC inaugurated its International Banking Unit (IBU) branch at GIFT City near Gandhinagar city in Gujarat.

S77. Ans.(b)

Sol. Board of Directors of Kerala-based Dhanlaxmi Bank have given approval to appoint J K Shivan as managing director and CEO of the Bank.

S78. Ans.(c)

Sol. PhonePe in partnership with ICICI Prudential Life Insurance Co Ltd launched Term Life Insurance plans on its platform.

S79. Ans.(d)

Sol. The book titled 'Right Under Your Nose' is authored by Reserve Bank of India (RBI) Manager R Giridharan.

S80. Ans.(b)

Sol. Indian Army has created a new human right cell at its headquarters (New Delhi). Major General Gautam Chauhan has been appointed as the 1st Additional Director General-ADG (Human Rights-HR).

S81. Ans.(c)

Sol. Former Indian captain and wicket-keeper batsman Mahendra Singh Dhoni has been named as the captain of the ICC ODI Team of the Decade by International Cricket Council (ICC).

S82. Ans.(a)

Sol. India's first hot air balloon wildlife safari in a tiger reserve has been introduced in Bandhavgarh Tiger Reserve, Madhya Pradesh.

S83. Ans.(a)

Sol. The steel lattice girder Koilwar Bridge (known as Sone Bridge when it was built) was the longest bridge in the subcontinent when built.

S84. Ans.(e)

Sol. PwC India has announced the rollout of a strategic collaboration with UNICEF and YuWaah (Generation Unlimited in India) to help bridge the digital gap. Under the initiative, 300 million young people in India will be upskilled over the next 10 years.

Ans.85.(b)

Sol. Raja Bhoj Airport is in Bhopal, Madhya Pradesh.

S86. Ans.(a)

Sol. Padmakumar M Nair has been appointed as the CEO of the proposed National Asset Reconstruction Company Ltd.

S87. Ans.(b)

Sol. Jana Small Finance Bank has announced the launch of the "I choose my number" feature for all its customers across India. This new feature gives the bank's existing and new customers the option to select their favourite numbers as their savings or current account number.

S88. Ans.(a)

Sol. Indian Renewable Energy Development Agency Ltd (IREDA) has been conferred with the "Green Urja Award" for being the Leading Public Institution in the Financing Institution for Renewable Energy this year by the Indian Chamber of Commerce (ICC).

S89. Ans.(c)

Sol. The International Nurses Day is celebrated on May 12, every year to mark the contributions and hard work of nursing staff around the world.

S90. Ans.(a)

Sol. London-based property consultant Knight Frank has ranked New Delhi and Mumbai in 32nd and 36th positions respectively in the Global Prime Residential Index.

S91. Ans.(d)

Sol. All the above is the characteristics of the management, management is continuous process, composite process and social process

S92. Ans.(c)

Sol. F.w Taylor developed principal of scientific management that why he was called as Father of scientific management

S93. Ans.(d)

Sol. Centralization means Concentration of authority at one place or at one level in the organisation.

S94. Ans.(d)

Sol. Organising is the process of establishing relationships among the member of the enterprise.

S95. Ans.(d)

Sol. Leadership is the sub function of directing

S96. Ans.(d)

Sol. To satisfy need of the customer, through product differentiation and increasing the demand of the product.

S97. Ans.(d)

Sol. Procurement of funds, along with Financing and investment decision to increase profit and reduce tax is main aspects of financial management.

S98. Ans.(b)

Sol. advertising is source of recruitment of employees other includes references by employees and so on.

S99. Ans.(a)

Sol. Strategy is a blend of proactive and reactive actions by the management.

S100. Ans.(b)

Sol. Strategic analysis involves evaluation of all situational or environment factors, whether internal or external.

S101. Ans.(a)

Sol. Strategic planning involves a fact of interactive and overlapping decisions leading to the development of an effective strategy for the firm.

S102. Ans.(d)

Sol. According to Herzberg, motivating factors are primarily intrinsic job elements that lead to satisfaction, such as achievement, recognition, the (nature of) work itself, responsibility, advancement, and growth. These are factors that can result in job dissatisfaction if not well managed

S103. Ans.(a)

Sol. Strategic leader is a change agent who initiates strategic changes in the organisation.

S104. Ans.(d)

Sol. A strategic audit is crucial for success as it requires taking into account market conditions and changes.

S105. Ans.(c)

Sol. Benchmarking helps in improving performance by learning from best practices and the processes by which they are achieved.

S106. Ans.(d)

Sol. The demographic issues that represents a challenge for human resource managers are

Increasing in diverse workforce : The workforce diversified due to change in architecture, language teaching, and the physical sciences

Aging workforce : The Older workers can be seen as poor performers, difficult to get along with, untrainable, unable to use technology, resistant to change.

S107. Ans.(d)

Sol. One of the primary benefits of rehiring retired workers is that they have a lifetime of professional experience. Older workers may be able to fill roles that require a high level of knowledge, skill and experience without any need for training.

S108. Ans.(c)

Sol. Strategy refers to a company's plan for how it will balance its internal strengths and weaknesses with external opportunities and threats in order to maintain a competitive advantage.

S109. Ans.(d)

Sol. Performance evaluation is a systematic process of evaluating how well employees are performing their jobs. It is evaluated based on measurable evidence of efficiency and effectiveness of the employee.

S110. Ans.(b)

Sol. The HR scorecard is a strategic HR measurement system that helps to measure, manage, and improve the strategic role of the HR department. The Managers uses HR scorecard to measure the HR function's effectiveness and efficiency in producing employee behaviors the company needs to achieve its strategic goals.

S111. Ans.(d)

Sol. The reason why this metric is used is simple: businesses want to be effective and efficient, and if your turnover costs are high, then something is wrong. Your turnover rate is the opposite of your retention rate, and can also give you an indication of the health of your team.

S112. Ans.(c)

Sol. A person who is the leader of a company or group who is Depicts the image of a model leader.

S113. Ans.(d)

Sol. SWOT Matrix contains nine cells in which four are key factor cells, four strategy cells and one blank cell.



BILINGUAL

SBI CLERK

Target Batch

For Prelims

Starts May 25, 2021

S114. Ans.(b)

Sol. Technology development activity is the activity that does not come under the primary activities of value Chain analysis. Value chain analysis is a strategy tool used to analyze internal firm activities. Its goal is to recognize, which activities are the most valuable (i.e. are the source of cost or differentiation advantage) to the firm and which ones could be improved to provide competitive advantage.

S115. Ans.(c)

Sol. Strategic implementation requires a firm to establish annual objectives, devise, policies, motivates employees and allocate resources and also is a process that puts plans and strategies into action to reach desired goals. The strategic plan itself is a written document that details the steps and processes needed to reach plan goals, and includes feedback and progress reports to ensure that the plan is on track.

S116. Ans.(b)

Sol. Industry/sector benchmarking compares Organisational performance between firms/public sector organisations in the same industry or sector. Competitive or Industry/sector benchmarking enables an organization to compare its performance with competitors trading in the same industry or sector. Functional or external benchmarking involves comparing your business activities with those of companies from other industries/sectors with similar processes.

S117. Ans.(b)

Sol. The term corporate strategy concerns strategy and strategic decisions means decision at all levels in an organization. Corporate strategy is hierarchically the highest strategic plan of the organization, which defines the corporate overall goals and Solutions and the way in which goals are achieved within strategic management activities. It is a long-term, clearly defined vision of the direction of a company or organization.

S118. Ans.(a)

Sol. Organizational structure is the method by which organizational activities are divided, organized, coordinated & controlled. The organizations created the structures to coordinate the. Activities of work factors and control the member performance.

S119. Ans.(b)

Sol. Normative ethics is the study of ethical behaviour that investigates the questions that arise regarding how one ought to act, in a moral sense while Metaethics is the study of moral thought and moral language, rather than addressing questions about what practices are right and wrong.

S120. Ans.(a)

Sol. Ethics and law often overlap by telling us how moral values should be maintained and makes sure that people do not violate them.

S121. Ans.(c)

Sol. Ethical issues occur when a given decision, scenario or activity creates a conflict with a society's moral principles. These conflicts are sometimes legally dangerous, since some of the alternatives to solve the issue might breach a particular law.

S122. Ans.(e)

Sol. Ethical compliance refers to a company's or a business person's conformity with relevant laws and regulations. A compliance and ethics program helps to ensure that an organization operates within the law and stays true to its own ethical principles.

S123. Ans.(d)

Sol. Ethical training helps workers to cultivate an ethical workplace, with more motivated and trustworthy employees. Whether it's a teaching company values, building mutual tolerance and integrity, or dealing with difficult customers; ethics training can help to create a safe and fair workplace.

S124. (b)

Sol. A code of conduct is a set of written rules outlining the norms, rules, and responsibilities or proper practices of an individual party or an organization. The document does not need to be complex or have elaborate policies. Failure of an employee following a company's code of conduct can have negative consequences.

S125. Ans.(c)

Sol. Price discrimination is the microeconomic pricing strategy of selling the same product at different prices to different buyers, in order to maximize sales and profits. There are three types of price discrimination - first-degree, second-degree, and third-degree price discrimination.

S126. Ans.(e)

Sol. Business leaders are well aware of the ethical issues and hence they want to improve the ethical standards of the business. Self-regulation is better and produces impressive results. Besides, there are also a number of factors, which significantly influence the managers to take ethical decisions.

S127. Ans.(c)

Sol. Managerial ethics is the rules and principles, decided by upper management, to spell out what is right and wrong in an organization. Managerial ethics makes it easier for managers to make the right decisions on the job when a conflict of values occurs.

NRA-CET Ready

**BANK
MAHA PACK**

Live Class, Video Course,
Test Series, eBooks

Bilingual (with eBooks)
12+12 Months Validity

S128. Ans.(e)

Sol. Ethics are the moral principles that govern the person's behaviour or conducting of an activity. This term is also applied on any system or theory of moral values or principles.

S129. Ans.(d)

Sol. Laws enforce the behaviours that we are expected to follow, while ethics suggest what we ought to follow, and help us explore options to improve our decision-making. Ethical decision-making comes from a person's moral sense and desire for self-respect.

S130. Ans.(d)

Sol. Duty is about following the rules laid down by external sources (be it a human society or a commander). Virtue is about internal guidance – following one's conscience to do the right thing

S131. Ans.(e)

Sol. Business ethics refers to contemporary organizational standards, principles, sets of values and norms that govern the actions and behaviour of an individual in the business organization.

S132. Ans.(c)

Sol. Ethics of care, also called as care ethics is a feminist philosophical perspective that uses a relational and context-bound approach toward morality and decision making. The term ethics of care refers to ideas concerning both the nature of morality and normative ethical theory.

S133. Ans.(d)

Sol. Virtue ethics is person based rather than action. It looks at the virtue or moral character of the person carrying out an action, rather than at ethical duties and rules, or the consequences of particular actions. A good person is someone who lives virtuously and lives the virtues.

S134. Ans.(b)

Sol. Deontology is the normative ethical theory that assumes that morality of an action should be based on whether that action itself is right or wrong under a series of rules, rather than based on the consequences of the action.

S135. Ans.(a)

Sol. Kant's theory is an example of a deontological moral theory. According to these theories, the rightness or wrongness of actions does not depend on their consequences but on whether they fulfil our duty.

S136. Ans.(c)

Sol. Sivaraman **committee** recommended the establishment of **NABARD**.

S137. Ans.(d)

Sol. Soil texture is the relative **proportions of sand, silt, or clay** in a soil.

S138. Ans.(c)

Sol. Food Safety and Standards Authority of India (FSSAI) is a statutory body established under the Ministry of Health & Family Welfare, Government of India. The FSSAI has its headquarters at New Delhi.

S139. Ans.(b)

Sol. The most important **insect** damaging **pulses** in **field and storage** are referred as bruchids or **pulse** beetles.

S140. Ans.(b)

Sol. The **maximum area under crops in India** is used for the **cultivation** of Rice.

S141. Ans.(b)

Sol. Sustainable agriculture is farming in sustainable ways meeting society's present food and textile needs, without compromising the ability for current or future generations to meet their needs.

S142. Ans.(c)

Sol. The present **cropping intensity** of 138% has registered an increase of only 25% since independence.

S143. Ans.(c)

Sol. The **water holding capacity** is **highest** in **sandy soil** **clay soil** **loamy soil** or mixture of sand and Loom, so it is **highest** in **clay soil**.

S144. Ans.(d)

Sol. **Utera cropping** is the sowing of the next **crop** seeds before harvesting of standing paddy **crop** in order to utilize moisture efficiently under rainfed agro-ecosystem. **Utera cropping** is only adopted in Rabi season.

S145. Ans.(c)

Sol. One of the major causes of this degradation could be increased frequency of high rainfall events in the region. The degradation could in fact be one of the reasons for the devastating surface floods, flash floods and landslides throughout the north eastern region of the country this year. Five states – Assam, Manipur, Tripura, Mizoram and Nagaland.

S146. Ans.(b)

Sol. Management of excess **water** in agriculture is a major challenge globally as well as in **India**, where about 11.6 **million ha area** is **waterlogged**.

S147. Ans.(b)

Sol. a rainy **day** has been defined as a **day** with **rainfall** of **2.5 mm** or **more rainfall**.

S148. Ans.(b)

Sol. The **pH of saline soils** is generally below 8.5.

S149. Ans.(d)

Sol. Commercial banks have the **highest** share in the disbursement of **credit** to **agriculture** and allied activities. The commercial banks disburse around 60% **credit** followed by cooperative banks around 30% and RRB and others.

S150. Ans.(c)

Sol. **Farmers** having less than two hectares (five acres) of **land** are called **small farmers** and those having less than one hectare (2.5 acres) are called **marginal farmers**.

S151. Ans.(d)

Sol. The government raised the **minimum support price (MSP)** of **paddy** per **quintal** to **Rs 1,888** per **quintal (grade a)** for the **2020-21** crop year.

S152. Ans.(a)

Sol. Triticale is the first man made cereal.

S153. Ans.(b)

Sol. **SSP** - A multi nutrient fertilizer containing **phosphorus** (14.5 %), **Sulphur** (11%) and **Calcium** (21 %).

S154. Ans.(b)

Sol. Punjab has **the highest** average **farming** household **income** in the country at **Rs 2,16,708** per year. While Bihar has the lowest at **Rs 42,684** per year.

S155. Ans.(c)

Sol. **Paddy procurement** for Kharif **2020-21** is continuing smoothly in the **procuring States** & UTs of Punjab, Haryana, Uttar Pradesh.

S156. Ans.(b)

Sol. **Sweet Revolution** in India - Mithi Kranti Or **Honey Mission**.

S157. Ans.(a)

Sol. Calcium, magnesium, and sulfur are essential plant **nutrients**. They are called "**secondary**" **nutrients**.



S158. Ans.(b)

Sol. The cost involved in moving the product from the point of production to point of consumption is called market cost.

S159. Ans.(a)

Sol. A **market** structure characterized by a single seller, selling a unique product in the **market**.

S160. Ans.(b)

Sol. To acquire and build godowns and warehouses at suitable places in India or abroad. To run warehouses for the **storage** of agricultural produce.

S161. Ans.(b)

Sol. **National markets** are found for **durable goods** like jute and tea.

S162. Ans.(c)

Sol. The Agricultural Produce (Grading and Marketing) Acts passed in the year 1937.

S163. Ans.(b)

Sol. The **law of Diminishing Returns** states that the result of adding a factor of production is a smaller increase in output.

S164. Ans.(c)

Sol. Commission for Agricultural Costs and Prices/ Formed 1 January 1965

S165. Ans.(a)

Sol. Vijay Paul Sharma **Commission for Agricultural Costs and Prices (CACP)** is a decentralised agency of the Government of India.

S166. Ans.(a)

Sol. A halophyte is a **salt-tolerant plant** that **grows in soil** or waters of high **salinity**.

S167. Ans.(d)

Sol. The **particles** that make up **soil** are categorized into three groups by **size** – sand, silt, and clay. Sand **particles** are the largest and clay **particles** the **smallest**.

S168. Ans.(c)

Sol. Soil **erosion**: splash **erosion** - sheet **erosion** - rill **erosion** - gully **erosion**.

S169. Ans.(b)

Sol. **RPDS** was launched with a view to strengthen and streamline the **PDS** as well as to improve its reach poor families especially in the far-flung, hilly, remote and inaccessible areas.

S170. Ans.(b)

Sol. The **Indian food security system** was established by the Government of **India under the Ministry** of Consumer Affairs, **Food and Public Distribution** to distribute **food** and non-**food** items to **India's** poor at subsidised rates.

S171. Ans.(e)

Sol. The **Central Government, through Food Corporation of India (FCI), has assumed the responsibility** for procurement, storage, transportation and bulk allocation of **food** grains to the State **Governments**.

S172. Ans.(b)

Sol. The **Revamped Public Distribution System (RPDS) was launched** in June, 1992.

S173. Ans.(a)

Sol. In order to make TPDS more focused and targeted towards this category of population, the "**Antyodaya Anna Yojana**" (AAY) was **launched** in December, 2000 for one crore poorest of the poor families.

S174. Ans.(a)

Sol. **Integrated Watershed Management Programme (IWMP) is implemented** by Department of Land Resources of Ministry of Rural **Development**. The main objective of **IWMP** is to restore ecological balance by harnessing, conserving and developing degraded natural resources such as soil, vegetative cover and **water**.

S175. Ans.(e)

Sol. **Soil conservation practices** are tools the farmer can use to prevent **soil** degradation and build organic matter. These **practices** include: crop rotation, reduced tillage, mulching, cover cropping and cross-slope farming.

S176. Ans.(a)

Sol. The Office Clipboard stores text and graphics that you copy or cut from anywhere, and it lets you paste the stored items into any other Office file.

S177. Ans.(a)

S178. Ans.(b)

Sol. OMR stands for Optical Mark Recognition. This technology is used to read the marked data on documents. It is widely used in examinations to check the marked answers.

S179. Ans.(d)

Sol. Blue Track mouse is a type of mouse that is based on the Blue Track Technology and can work on any surface from granite countertop to the carpet.

S180. Ans.(b)

Sol. We can use the filters to block Web pages or websites that contains objectionable content or advertisement.

TEST SERIES

ENGLISH



FCI 2021

**ASST. GENERAL MANAGER
(General Administration)**

20 TOTAL TESTS



BOOKS

50+ BANK PO CLERK 2016-2021 PREVIOUS YEARS' Memory Based Papers Edition 3.0 500+ Questions 6500+ Detailed Solutions of English & Reasoning	50+ बैंक पीओ/ क्लर्क 2016-2021 पिछले वर्षों की याददाश्त आधारित प्रश्नपत्रिका Edition 3.0 300 हिन्दी में प्रश्न 6000+ विस्तृत समाधान	20+ SBI CLERK PRELIMS MOCK PAPERS Based on Latest Pattern 17 Prelims Mock Papers 2100 Questions with 100% Solutions	A Complete Book of PUZZLE & SEATING ARRANGEMENT Useful for Banking & Insurance Examinations for IBPS, SBI, LIC, LIC & Others 3200+ Questions	20+ IBPS CLERK PRELIMS MOCK PAPERS Based on Latest Pattern 20 IBPS Clerk Prelims Mock Papers 2100 Questions with 100% Solutions	"THE CRACKER" BANK MAINS EXAMS Bank mains for IBPS SBI RRB PO-CLERK 2000+ Questions 3500+ Detailed Solutions	COMPREHENSIVE GUIDE FOR INTELLIGENCE BUREAU ACIO GRADE-II 3500+ Questions
A COMPLETE BOOK OF DATA INTERPRETATION & ANALYSIS Useful for Banking & Insurance Examinations for IBPS, SBI, LIC, LIC & Others 2000+ Questions	25+ IBPS RRB PO & CLERK PRELIMS MOCK PAPERS Based on Latest Pattern English Medium 2240 Questions with 100% Solutions	Ace QUANT A Complete Guide for Quantitative Aptitude 1000+ Questions with 100% Solutions	ऐस क्वान्ट एक पूर्ण गाइड क्वान्टिटेटिव अप्टीट्यूड के लिए 1000+ प्रश्नों के साथ 100% समाधान	Ace REASONING A Complete Guide for Reasoning Aptitude 1000+ Questions with 100% Solutions	ऐस रीजनिंग एक पूर्ण गाइड रीजनिंग अप्टीट्यूड के लिए 1000+ प्रश्नों के साथ 100% समाधान	Ace BANKING & STATIC AWARENESS 1000+ Questions with 100% Solutions
Ace IT OFFICER Professional Knowledge 1000+ Questions with 100% Solutions	COMPUTER APTITUDE For Banking & Insurance Examinations 1000+ Questions with 100% Solutions	BANK EXAMS INTERVIEWS A Guide to Crack 1000+ Questions with 100% Solutions	100+ SSC CGL TIER-I / PRELIMS Previous Years' Papers & Mock Tests Practice Book English Medium 1000+ Questions with 100% Solutions	A Comprehensive Guide for RRC GROUP 'D' 4000+ Questions with 100% Solutions	A COMPLETE BOOK OF LOGICAL REASONING Useful for IBPS SBI LIC Insurance & Other Exams 550+ Questions	"THE CRACKER" PRACTICE BOOK FOR GEOMETRY Useful for SSC CGL CPO CHSL & Other Exams 800+ Questions 3500+ Detailed Solutions
उत्तर प्रदेश पुलिस UP Police Recruitment 2020 (M & ASI) 3500+ Questions with 100% Solutions	A Comprehensive Guide for DELHI POLICE CONSTABLE Useful for UP Police, Bihar Police, Forest Guard & Other Exams 3000+ Questions with 100% Solutions	50+ SSC CGL TIER - I MOCK PAPERS PRACTICE BOOK Useful for SSC CGL, CHSL, and CPO 5100 Questions with 100% Solutions	20+ SSC CGL TIER-I PREVIOUS YEAR MOCK PAPERS PRACTICE BOOK Useful for SSC CGL, CHSL & CPO 2100 Questions with 100% Solutions	"THE CRACKER" PRACTICE BOOK FOR ALGEBRA & NUMBER SYSTEM 1300+ Questions	"THE CRACKER" PRACTICE BOOK FOR MENSURATION Useful for SSC CGL CPO CHSL & Other Exams 850+ Questions	Ace SSC ARITHMETIC 1000+ Questions with 100% Solutions
ऐस एसएससी अंक गणित एक पूर्ण गाइड अंकगणित के लिए	Ace SSC ENGLISH LANGUAGE & COMPREHENSION BOOK 1000+ Questions with 100% Solutions	Ace SSC ADVANCED MATHS 1000+ Questions with 100% Solutions	ऐस एसएससी एवरेज मैथ एक पूर्ण गाइड एवरेज मैथ के लिए	Ace SSC GENERAL AWARENESS History Geography Polity Current Affairs Olympiad Banking 1000+ Questions with 100% Solutions	ऐस एसएससी सामान्य जागरूकता इतिहास भूगोल नीति वर्तमान घटनाएं ओलंपियाड बैंकिंग	Ace SSC GENERAL INTELLIGENCE & REASONING 1000+ Questions with 100% Solutions

Visit: adda247.com
 For any information, mail us at support.publication@adda247.com