

S1. Ans.(a)

$$\text{Sol. } \frac{3}{8} \times 4200 + 625 + 1000 - 700 = (?)^2$$

$$(?)^2 = 1575 + 625 + 1000 - 700 = 2500$$

$$? = 50$$

S2. Ans.(c)

$$\text{Sol. } \frac{?+62.5}{3} + 360 - 144 - 20 = 169 + 87$$

$$? + 62.5 = (169 + 87 + 144 + 20 - 360) \times 3$$

$$? = 180 - 62.5 = 117.5$$

S3. Ans.(d)

$$\text{Sol. } 270 + 121 - \sqrt{?} = 361$$

$$\sqrt{?} = 30$$

$$? = 900$$

S4. Ans.(b)

$$\text{Sol. } \frac{624}{?} + 21 + 27 = 36 + 220$$

$$\frac{624}{?} = 208$$

$$? = \frac{624}{208} = 3$$

S5. Ans.(a)

$$\text{Sol. } \frac{?}{100} \times 625 + \frac{1}{3} \times 750 + \frac{1}{11} \times 5500 - 25 = 1000$$

$$? \times 6.25 + 250 + 500 - 25 = 1000$$

$$? \times 6.25 = 275$$

$$? = 44$$

S6. Ans.(a)

$$\text{Sol. } ? = 2358$$

S7. Ans.(c)

$$\text{Sol. } \frac{7525}{25} + \frac{3125}{5 \times 5 \times 5 \times 5} - 210 = ?$$

$$? = 301 + 5 - 210 = 96$$

S8. Ans.(e)

$$\text{Sol. } \frac{1400}{4} - 466 + 120 = ?$$

$$? = 4$$

S9. Ans.(c)

$$\text{Sol. } = \frac{(23+37)^2}{(19+11)^2} = \frac{60^2}{30^2} = 4 = 2^2$$

$$? = 2$$

S10. Ans.(a)

$$\text{Sol. } \frac{64+16+4}{324+144+36} = \frac{1}{6}$$

$$? = 6$$

S11. Ans.(d)

$$\text{Sol. } 2^5 + 2^{10} = ? \times 12$$

$$\frac{2^{5(1+32)}}{12} = ?$$

$$\Rightarrow ? = 88$$

S12. Ans.(a)

$$\text{Sol. } \sqrt{256} + \sqrt{784} = ? \times \sqrt{121}$$

$$16 + 28 = ? \times 11$$

$$? = \frac{44}{11} = 4$$

S13. Ans.(d)

$$\text{Sol. } 80\% \text{ of } 350 + 45\% \text{ of } 800 = ? \times 256$$

$$280 + 360 = ? \times 256$$

$$? = \frac{640}{256} = 2.5$$

S14. Ans.(e)

$$\text{Sol. } 115\% \text{ of } 360 + 180\% \text{ of } 270 = ? \times 225$$

$$414 + 486 = ? \times 225$$

$$? = \frac{900}{225} = 4$$

S15. Ans.(b)

$$\text{Sol. } 9^? \times 729 = \frac{3^4 \times 9^6}{81}$$

$$9^? = \frac{9^2 \times 9^6}{9^2 \times 9^3} = 9^3$$

$$\Rightarrow ? = 3$$

S16. Ans.(d)

$$\text{Sol. } 5\frac{1}{4} + 7\frac{1}{3} + 4\frac{1}{2} = 3\frac{1}{6} + ? + 5\frac{1}{6}$$

$$(5 + 7 + 4) + \left(\frac{1}{4} + \frac{1}{3} + \frac{1}{2}\right) - 3 - 5 - \frac{1}{6} - \frac{1}{6} = ?$$

$$8 + \frac{1}{4} + \frac{1}{2} + \frac{1}{3} - \frac{1}{3} = ?$$

$$? = 8 + \frac{2+4}{8} = 8\frac{3}{4}$$

S17. Ans.(b)

$$\text{Sol. } 37\frac{1}{2}\% \text{ of } 300 + 62\frac{1}{2}\% \text{ of } 460 = ?$$

$$? = \frac{75}{200} \times 300 + \frac{125}{200} \times 460$$

$$= \frac{225}{2} + \frac{575}{2} = 400$$

S18. Ans.(d)

$$\text{Sol. } 75\% \times 160 + 45\% \times 300 = ? \times 17$$

$$? \times 17 = \frac{3}{4} \times 160 + \frac{9}{20} \times 300$$

$$? = \frac{120+135}{17} = \frac{255}{17} = 15$$

S19. Ans.(c)

$$\text{Sol. } 28\frac{2}{7} \times 5\frac{8}{11} + ? = 36\frac{1}{9} \times 7\frac{8}{13}$$

RBI Office Attendant | Free Practice PDF | All Subjects | PDF-1 | Solutions

$$\frac{198}{7} \times \frac{63}{11} + ? = \frac{325}{9} \times \frac{99}{13}$$

$$? = 275 - 162$$

$$? = 113$$

S20. Ans.(d)

$$\text{Sol. } ? = \frac{255 \times 272 \times 153}{102 \times 204 \times 85} = 6$$

S21. Ans.(d)

$$\text{Sol. } \sqrt{?} \approx (1347 + 53) \div 100 - 7$$

$$\Rightarrow \sqrt{?} \approx 14 - 7$$

$$\Rightarrow \sqrt{?} \approx 7$$

$$\Rightarrow ? \approx 49$$

S22. Ans.(e)

$$\text{Sol. } 2^? \approx 32^2 \times 8 \times 34^2 \div (2^9 \times 17^2)$$

$$\approx \frac{2^{15} \times 17^2}{2^9 \times 17^2}$$

$$2^? \approx 2^6$$

$$\Rightarrow ? \approx 6$$

S23. Ans.(e)

$$\text{Sol. } \left(\frac{15}{100} \times 4800\right) \div ? \approx \left(\frac{60}{100} \times 4\right)^2$$

$$\Rightarrow ? \approx \frac{72,000}{24 \times 24}$$

$$\Rightarrow ? \approx 125$$

S24. Ans.(a)

$$\text{Sol. } \frac{3}{20} \times 240 \approx ? \div (2 \times 1)$$

$$\Rightarrow ? \approx 72$$

S25. Ans.(a)

$$\text{Sol. } ? \approx \frac{36}{9} \times 10 + 40$$

$$\approx 40 + 40$$

$$? \approx 80$$

S26. Ans.(d)

$$\text{Sol. } ? \approx (\sqrt{625} + \sqrt{1600}) \div \left(\frac{560 \times 30}{100} - \frac{250 \times 62}{100}\right)$$

$$? \approx \frac{(25+40)}{(168-155)} \approx \frac{65}{13} = 5$$

S27. Ans.(b)

$$\text{Sol. } ? \approx \frac{729 \times 81 \times 108}{27 \times 36} = 6561$$

S28. Ans.(e)

$$\text{Sol. } ?^2 + (32)^2 - \sqrt{144} \times 8^2 \approx 73\% \text{ of } 400$$

$$?^2 + 1024 - 12 \times 64 = 292$$

$$?^2 \approx 292 - 1024 + 768$$

$$?^2 \approx 36$$

$$? \approx 6$$

S29. Ans.(a)

$$\text{Sol. } 48\% \text{ of } 350 + 60\% \text{ of } 280 \approx 97\% \text{ of } 300 + ?\% \text{ of } 150$$

$$\Rightarrow ? \times 1.5 \approx 168 + 168 - 291$$

$$? \approx \frac{45}{1.5} = 30$$

S30. Ans.(e)

$$\text{Sol. } 2^? \approx \frac{128 \times 512 \times 16}{2048 \times 32} \approx 16$$

$$2^? \approx 2^4$$

$$\Rightarrow ? = 4$$

S31. Ans.(b)

$$\text{Sol. } ? \approx 21 + 5 \times 8 + 10$$

$$\approx 71$$

S32. Ans.(b)

$$\text{Sol. } \approx \frac{75}{100} \times 256 + \frac{40}{\sqrt{x}} = \frac{48}{100} \times 650$$

$$\approx 192 + \frac{40}{\sqrt{x}} = 312$$

$$\approx \frac{40}{\sqrt{x}} = 120$$

$$\approx x = \left(\frac{40}{120}\right)^2$$

$$\approx x = \frac{1}{9}$$

S33. Ans.(a)

$$\text{Sol. } \approx 294 \times \frac{x}{8} - \frac{1}{5} \times 120x = \frac{255}{2}$$

$$\approx 36.75x - 24x = 127.5$$

$$\approx 12.75x = 127.5$$

$$\approx x = 10$$

S34. Ans.(e)

$$\text{Sol. } 32^2 - 12^2 + \frac{2009}{?} \approx 900$$

$$\Rightarrow ? \approx \frac{2009}{20}$$

$$\Rightarrow ? \approx 100$$

S35. Ans.(b)

$$\text{Sol. } ? \approx \frac{1575}{45} + 24 \times 16$$

$$\approx 419$$

$$\approx 420 \text{ s}$$

S36. Ans.(c)

$$\text{Sol. } \approx \frac{180}{100} \times 25500 + \frac{50}{100} \times 29000$$

RBI Office Attendant | Free Practice PDF | All Subjects | PDF-1 | Solutions

$$\approx 45900 + 14500$$

$$= 60400$$

S37. Ans.(e)

Sol. $\approx \frac{77}{7} \times 6 \approx 66$

S38. Ans.(a)

Sol. $\approx (16)^2 - (9)^2$ [Using $a^2 - b^2 = (a + b)(a - b)$]
 $\approx 25 \times 7 \approx 175$

S39. Ans.(e)

Sol. $= (7171 + 3854 + 1195) \div (892 + 214 + 543)$
 $= 12220 \div 1649 \approx 7$

S40. Ans.(c)

Sol. $\approx 4 \times 36$
 $\approx 144 \approx 145$

S41. Ans.(c)

Sol. Pattern of series -

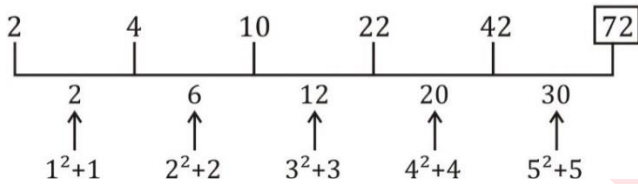

S42. Ans.(d)

Sol. Pattern of series -

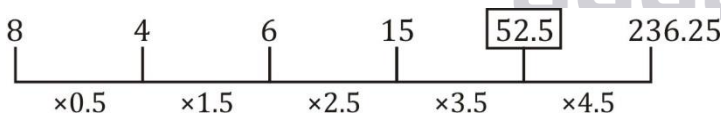

S43. Ans.(a)

Sol. Pattern of series -

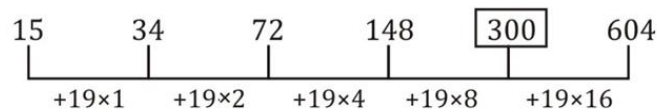

S44. Ans.(d)

Sol. Pattern of series -

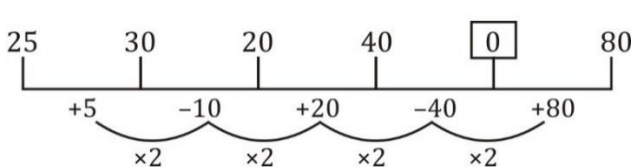

S45. Ans.(c)

Sol. Pattern of series -

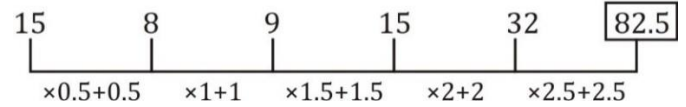

S46. Ans.(b)

Sol. Pattern of series -

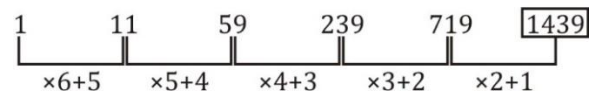

S47. Ans.(d)

Sol. Pattern of series -

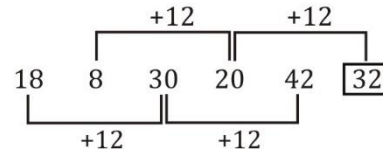

S48. Ans.(b)

Sol. Pattern of series -

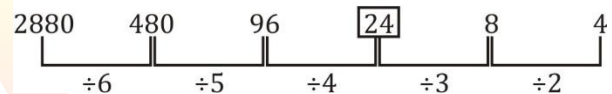

S49. Ans.(e)

Sol. Pattern of series -

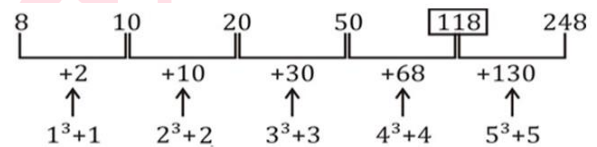

S50. Ans.(c)

Sol. Pattern of series -

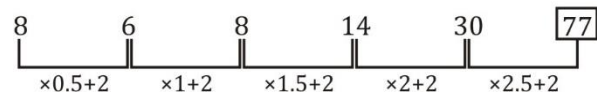

S51. Ans.(b)

Sol. Pattern of series -

$$18 \times 3 + 1 = 55$$

$$55 \times 3 + 2 = 167$$

$$167 \times 3 + 3 = 504$$

$$504 \times 3 + 4 = 1516$$

S52. Ans.(a)

RBI Office Attendant | Free Practice PDF | All Subjects | PDF-1 | Solutions

Sol. Pattern of series -

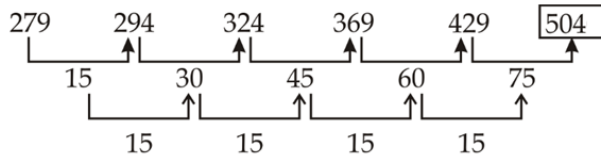

S53. Ans.(d)

Sol. Pattern of series -

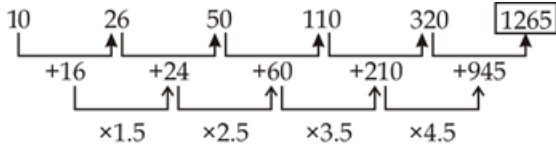

S54. Ans.(b)

Sol. Pattern of series -

$$\frac{286}{2} - 1 = 142, \frac{142}{2} - 1 = 70, \frac{70}{2} - 1 = 34, \frac{34}{2} - 1 = 16$$

S55. Ans.(c)

Sol. Pattern of series -

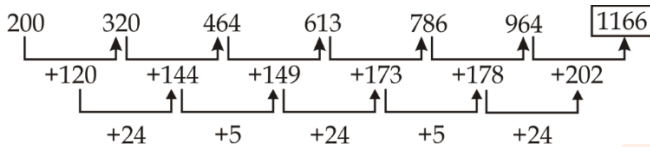

S56. Ans.(d)

Sol. Pattern of series -

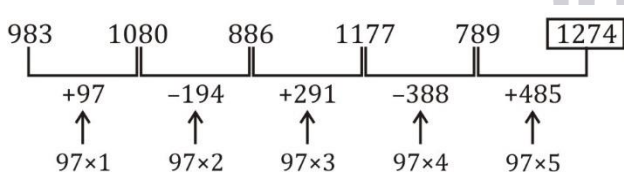

S57. Ans.(c)

Sol. Pattern of series -

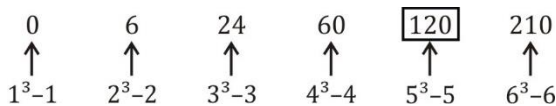

S58. Ans.(a)

Sol. Pattern of series -

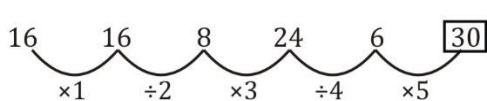

S59. Ans.(b)

Sol. Pattern of series -

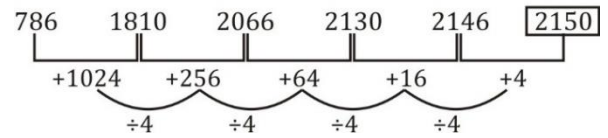

S60. Ans.(e)

Sol. Pattern of series -

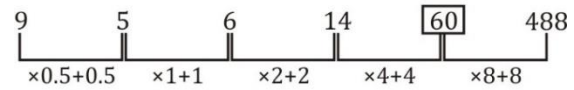

S61. Ans.(c)

Sol. The wrong no. is 1

The series is

$$0.5 \times 4 + 1 = 3$$

$$3 \times 4 + 1 = 13$$

$$13 \times 4 + 1 = 53$$

$$53 \times 4 + 1 = 213$$

$$213 \times 4 + 1 = 853$$

$$853 \times 4 + 1 = 3413$$

So, 0.5 will come in place of 1.

S62. Ans.(a)

Sol. The wrong no. is 166.

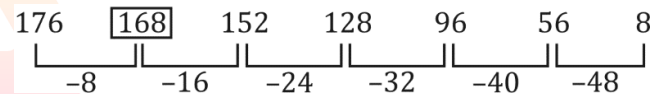

∴ Correct no. is 168 instead of 166.

S63. Ans.(e)

Sol. The wrong no. is -4.

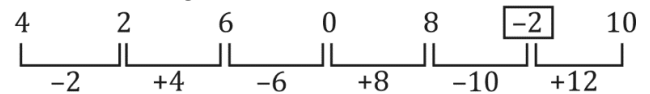

∴ Correct no. is -2 instead of -4.

S64. Ans.(b)

Sol. The wrong no. is 244.

The pattern is

$$16 + 1^3 = 17$$

$$17 + 2^3 = 25$$

$$25 + 3^3 = 52$$

$$52 + 4^3 = 116$$

$$116 + 5^3 = 241$$

$$241 + 6^3 = 457$$

$$457 + 7^3 = 800$$

∴ Correct no. is 241 instead of 244.

S65. Ans.(e)

Sol. the wrong no. is 8.4.

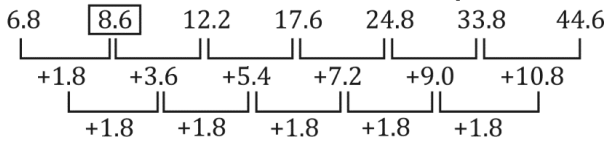

∴ Correct no. is 8.6 instead of 8.4.

S66. Ans.(a)

Sol. Wrong no. is 59

$5 + (2)^2 = 9$

$9 + (4)^2 = 25$

$25 + (6)^2 = 61$

$61 + (8)^2 = 125$

$125 + (10)^2 = 225$

$225 + (12)^2 = 369$

So, there should be 61 in place of 59.

S67. Ans.(c)

Sol. Wrong no. is 615

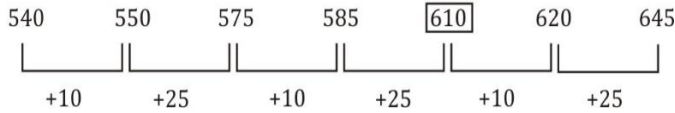

So, there should be 610 in place of 615

S68. Ans.(b)

Sol. Wrong no. is 221

$(1)^3 + 3 = 4$

$(2)^3 + 3 = 11$

$(3)^3 + 3 = 30$

$(4)^3 + 3 = 67$

$(5)^3 + 3 = 128$

$(6)^3 + 3 = 219$

$(7)^3 + 3 = 346$

So, there should be 219 in place of 221

S69. Ans.(d)

Sol. Wrong no. is 1.75

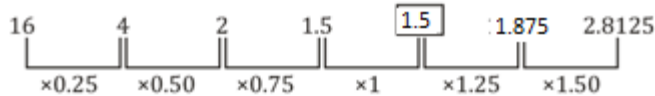

So, there should be 1.5 in place of 1.75

S70. Ans.(a)

Sol. Wrong no. is 148

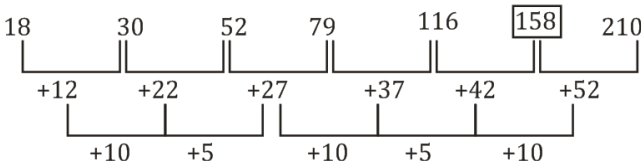

So, there should be 158 in place of 148.

S71. Ans.(b)

Sol. The wrong no. is 946

The series is $\times 0.5, \times 1.5, \times 2.5, \times 3.5, \times 4.5, \times 5.5$

$\therefore 210 \times 4.5 = 945$

So, there should be 945 instead of 946.

S72. Ans.(a)

Sol. The wrong no. is 4

$5 + 7 = 12$

$7 + 12 = 19$

$12 + 19 = 31$

$19 + 31 = 50$

$31 + 50 = 81$

So, there should be 5 instead of 4

S73. Ans.(c)

Sol. The wrong no. in this series is 135

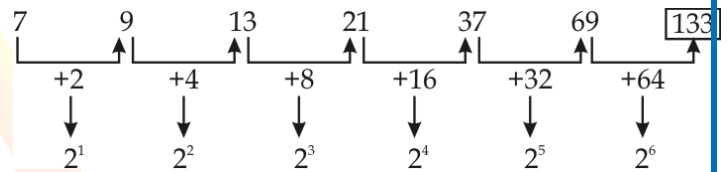

So, there should be 133 instead of 135.

S74. Ans.(d)

Sol. The wrong no. is 210

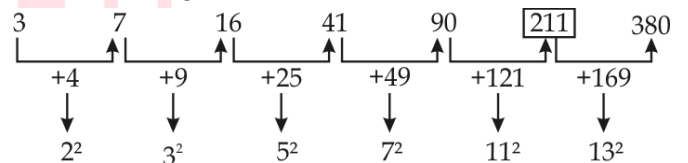

So, there should be 211 instead of 210

S75. Ans.(e)

Sol. The wrong no. is 50

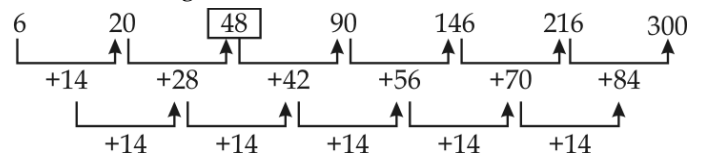

So, there should be 48 instead of 50.

S76. Ans.(d)

Sol. The wrong no. is 221

The series is $3 + 2^2 = 7$

$7 + 4^2 = 23$

RBI Office Attendant | Free Practice PDF | All Subjects | PDF-1 | Solutions

$$23 + 6^2 = 59$$

$$59 + 8^2 = 123$$

$$123 + 10^2 = 223$$

$$223 + 12^2 = 367$$

So, there should be 223 instead of 221.

S77. Ans.(e)

Sol. The wrong no. is 10532.

The series is $8 \times 0.5 + 1 = 5$

$$5 \times 1 + 2 = 7$$

$$7 \times 2 + 4 = 18$$

$$18 \times 4 + 8 = 80$$

$$80 \times 8 + 16 = 656$$

$$656 \times 16 + 32 = 10528$$

So, there should be 10528 instead of 10532.

S78. Ans.(b)

Sol. Wrong number = 96

Pattern of series -

$$56 + 14 = 70$$

$$70 + 28 = 98$$

$$98 + 56 = 154$$

$$154 + 112 = 266$$

$$266 + 224 = 490$$

$$490 + 448 = 938$$

So, there should be 98 in place of 96.

S79. Ans.(c)

Sol. The wrong no. is 8.

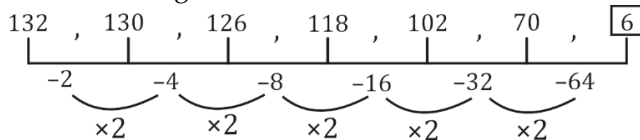

So, there should be 6 instead of 8.

S80. Ans.(b)

Sol. The wrong no. is 7.

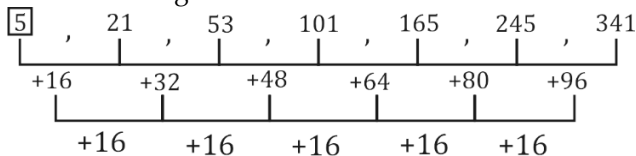

So, there should be 5 instead of 7.

S81. Ans.(a)

Sol. $x^2 - 14x + 48 = 0$

$$x^2 - 6x - 8x + 48 = 0$$

$$x(x - 6) - 8(x - 6) = 0$$

$$(x - 8)(x - 6) = 0$$

$$x = 8, 6$$

II. $2y^2 - 13y + 21 = 0$

$$2y^2 - 6y - 7y + 21 = 0$$

$$2y(y - 3) - 7(y - 3) = 0$$

$$(2y - 7)(y - 3) = 0$$

$$y = \frac{7}{2}, 3$$

$$x > y$$

S82. Ans.(d)

Sol. I. $\sqrt{(x - 4)(x + 8)} = 8$

$$(x - 4)(x + 8) = 64$$

$$x^2 + 8x - 4x - 32 - 64 = 0$$

$$x^2 + 4x - 96 = 0$$

$$x^2 + 12x - 8x - 96 = 0$$

$$x(x + 12) - 8(x + 12) = 0$$

$$(x - 8)(x + 12) = 0$$

$$x = 8, -12$$

II. $y^2 - 17y + 72 = 0$

$$y^2 - 17y + 72 = 0$$

$$y^2 - 9y - 8y + 72 = 0$$

$$y(y - 9) - 8(y - 9) = 0$$

$$(y - 8)(y - 9) = 0$$

$$y = 8, 9$$

$$y \geq x$$

S83. Ans.(a)

Sol. I. $2x^2 + 17x + 36 = 0$

$$2x^2 + 8x + 9x + 36 = 0$$

$$2x(x + 4) + 9(x + 4) = 0$$

$$(2x + 9)(x + 4) = 0$$

$$x = -\frac{9}{2}, -4$$

II. $3y^2 + 34y + 96 = 0$

$$3y^2 + 34y + 96 = 0$$

$$3y^2 + 18y + 16y + 96 = 0$$

$$3y(y + 6) + 16(y + 6) = 0$$

$$(3y + 16)(y + 6) = 0$$

$$y = -\frac{16}{3}, -6$$

$$x > y$$

S84. Ans.(c)

Sol. I. $x^2 + 2x - 15 = 0$

$$x^2 + 5x - 3x - 15 = 0$$

$$x(x + 5) - 3(x + 5) = 0$$

$$(x - 3)(x + 5) = 0$$

$$x = 3, -5$$

II. $y^2 - 10y + 24 = 0$

$$y^2 - 6y - 4y + 24 = 0$$

$$y(y - 6) - 4(y - 6) = 0$$

RBI Office Attendant | Free Practice PDF | All Subjects | PDF-1 | Solutions

$$(y - 4)(y - 6) = 0$$

$$y = 4, 6$$

$$y > x$$

S85. Ans.(e)

Sol. $x^2 - x - 12 = 0$

$$x^2 - 4x + 3x - 12 = 0$$

$$x(x - 4) + 3(x - 4) = 0$$

$$(x + 3)(x - 4) = 0$$

$$x = -3, 4$$

II. $y^2 - 9y + 18 = 0$

$$y^2 - 6y - 3y + 18 = 0$$

$$y(y - 6) - 3(y - 6) = 0$$

$$(y - 3)(y - 6) = 0$$

$$y = 3, 6$$

No relation can be established between x and y

S86. Ans (c)

Sol. I. $4x^2 + 4x + 1 = 0$

$$(2x + 1)^2 = 0$$

$$x = -\frac{1}{2}$$

II. $9y^2 + 6y + 1 = 0$

$$(3y + 1)^2 = 0$$

$$y = -\frac{1}{3}$$

$$\therefore x < y$$

S87. Ans.(e)

Sol. I. $(x - 2)^2 = 4$

$$x - 2 = \pm 2$$

$$x = 0, 4$$

II. $y^2 - 2y + 1 = 0$

$$(y - 1)^2 = 0$$

$$y = 1$$

\therefore no relation can be obtained.

S88. Ans.(e)

Sol. I. $3x + 2y = 5$

II. $4x + 6y = 10$

Applying $2 \times$ I and equate with II

$$x = y = 1$$

$$\therefore x = y$$

S89. Ans.(d)

Sol. I. $x^2 - 4x - 21 = 0$

$$x^2 - 7x + 3x - 21 = 0$$

$$x(x - 7) + 3(x - 7) = 0$$

$$(x + 3)(x - 7) = 0$$

$$x = -3, 7$$

II. $y^2 - 16y + 63 = 0$

$$y^2 - 7y - 9y + 63 = 0$$

$$y(y - 7) - 9(y - 7) = 0$$

$$(y - 7)(y - 9) = 0$$

$$y = 7, 9$$

So, $y \geq x$

S90. Ans.(a)

Sol. I. $2x = 3y - 1$

II. $x + y = 7$

Applying $2 \times$ II - I

$$2x + 2y - 2x = 14 - 3y + 1$$

$$5y = 15$$

$$y = 3$$

$$\text{And } x = 4$$

$$\therefore x > y$$

S91. Ans.(d)

Sol. I. $2x^2 - 17x + 36 = 0$

$$2x^2 - 8x - 9x + 36 = 0$$

$$2x(x - 4) - 9(x - 4) = 0$$

$$(2x - 9)(x - 4) = 0$$

$$x = \frac{9}{2}, 4$$

II. $2y^2 - 19y + 45 = 0$

$$2y^2 - 10y - 9y + 45 = 0$$

$$2y(y - 5) - 9(y - 5) = 0$$

$$(2y - 9)(y - 5) = 0$$

$$y = \frac{9}{2}, 5$$

$$\therefore y \geq x$$

S92. Ans.(e)

Sol. I. $x^2 - 25x + 154 = 0$

$$x^2 - 14x - 11x + 154 = 0$$

$$x(x - 14) - 11(x - 14) = 0$$

$$(x - 11)(x - 14) = 0$$

$$x = 11, 14$$

II. $y^2 - 28y + 195 = 0$

$$y^2 - 13y - 15y + 195 = 0$$

$$y(y - 13) - 15(y - 13) = 0$$

$$(y - 13)(y - 15) = 0$$

$$y = 13, 15$$

∴ no relation

S93. Ans.(a)

Sol. I. $\frac{10}{x} - \frac{24}{x^2} = 1$

Multiplying by x^2 on both side

$$10x - 24 = x^2$$

$$x^2 - 10x + 24 = 0$$

$$x^2 - 6x - 4x + 24 = 0$$

$$x(x - 6) - 4(x - 6) = 0$$

$$(x - 4)(x - 6) = 0$$

$$x = 4, 6$$

II. $\frac{5}{y} - \frac{6}{y^2} = 1$

Multiplying by y^2 on both side

$$5y - 6 = y^2$$

$$y^2 - 5y + 6 = 0$$

$$y^2 - 3y - 2y + 6 = 0$$

$$y(y - 3) - 2(y - 3) = 0$$

$$(y - 2)(y - 3) = 0$$

$$y = 2, 3$$

∴ $x > y$

S94. Ans.(d)

Sol. I. $3x^2 - 10x - 8 = 0$

$$3x^2 - 12x + 2x - 8 = 0$$

$$3x(x - 4) + 2(x - 4) = 0$$

$$(3x + 2)(x - 4) = 0$$

$$x = -\frac{2}{3}, 4$$

II. $2y^2 - 23y + 60 = 0$

$$2y^2 - 8y - 15y + 60 = 0$$

$$2y(y - 4) - 15(y - 4) = 0$$

$$(y - 4)(2y - 15) = 0$$

$$y = 4, \frac{15}{2}$$

∴ $y \geq x$

S95. Ans.(a)

Sol. I. $12x - 16y + 16 = 0$

$$3x - 4y + 4 = 0 \quad \dots(i)$$

$$II. 17y - 13x = 12 \quad \dots(ii)$$

By multiplying equation (i) by 13 & equation (ii) by 3

$$39x - 52y = -52$$

$$-39x + 51y = 36$$

$$y = 16 \text{ \& } x = 20$$

∴ $x > y$

S96. Ans.(e)

Sol. I. $x^2 + 9x - 22 = 0$

$$\Rightarrow x^2 + 11x - 2x - 22 = 0$$

$$\Rightarrow (x + 11)(x - 2) = 0$$

$$\Rightarrow x = -11, 2$$

II. $2y^2 - 7y + 6 = 0$

$$\Rightarrow 2y^2 - 4y - 3y + 6 = 0$$

$$\Rightarrow 2y(y - 2) - 3(y - 2) = 0$$

$$\Rightarrow (y - 2)(2y - 3) = 0$$

$$\Rightarrow y = 2, \frac{3}{2}$$

No relation

S97. Ans.(e)

Sol. I. $2y^2 - 13y - 34 = 0$

$$\Rightarrow 2y^2 - 17y + 4y - 34 = 0$$

$$\Rightarrow y(2y - 17) + 2(2y - 17) = 0$$

$$\Rightarrow (2y - 17)(y + 2) = 0$$

$$\Rightarrow y = \frac{17}{2}, -2$$

II. $3x^2 - 11x - 20 = 0$

$$\Rightarrow 3x^2 - 15x + 4x - 20 = 0$$

$$\Rightarrow 3x(x - 5) + 4(x - 5) = 0$$

$$\Rightarrow (x - 5)(3x + 4) = 0$$

$$\Rightarrow x = 5, -\frac{4}{3}$$

No relation

S98. Ans.(c)

Sol. I. $x^4 = 256$

$$\Rightarrow x = \pm 4$$

II. $y^2 - 16y + 64 = 0$

$$\Rightarrow (y - 8)^2 = 0$$

$$\Rightarrow y = 8$$

$$y > x$$

S99. Ans.(a)

Sol. I. $x^2 - 19x + 88 = 0$

$$x^2 - 11x - 8x + 88 = 0$$

$$x(x - 11) - 8(x - 11) = 0$$

$$x = 8, 11$$

II. $y^2 + y - 56 = 0$

$$y^2 + 8y - 7y - 56 = 0$$

$$y(y + 8) - 7(y + 8) = 0$$

$$y = 7, -8$$

$$x > y$$

S100. Ans.(d)

Sol. I. $(x - 1)^2 = 121$

$$x - 1 = \pm 11$$

$$x = 12, -10$$

II. $y^2 - 24y + 144 = 0$

$$(y - 12)^2 = 0$$

y = 12
So, y ≥ x

Solution (101-103):

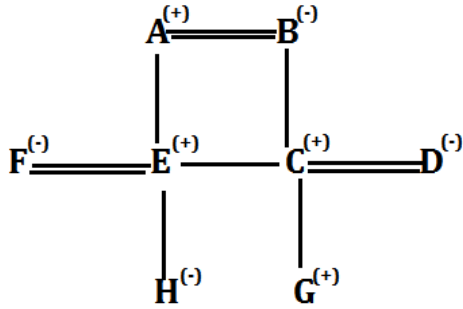

- S101. Ans.(a)
- S102. Ans.(c)
- S103. Ans.(c)

- S104. Ans.(b)
- S105. Ans.(a)
- S106. Ans.(d)
- S107. Ans.(b)

Solution (108-112):

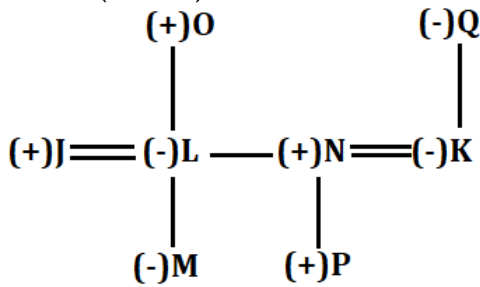

- S108. Ans.(a)
- S109. Ans.(d)
- S110. Ans.(a)
- S111. Ans.(e)
- S112. Ans.(b)

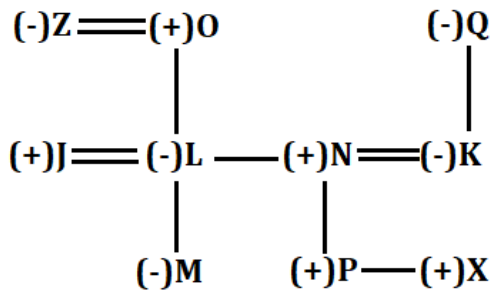

Solution (113-117):

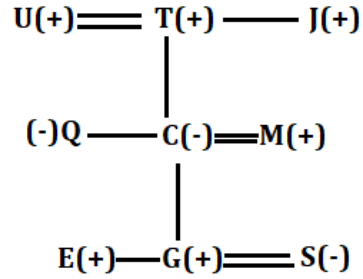

- S113. Ans.(a)
- S114. Ans.(a)
- S115. Ans.(e)
- S116. Ans.(b)
- S117. Ans.(c)

Solution (118-120):

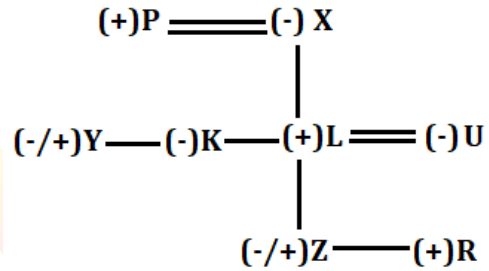

- S118. Ans.(e)
- S119. Ans.(c)
- S120. Ans.(b)

Solution (121-125):

Word	Code
Rainfall	mn
Target	vo
Today	na
Rises	sa
Strong/Higher	ra/ta
Inquiry	la
Victory/Plant	ha/ja

- S121. Ans.(c)
- S122. Ans.(b)
- S123. Ans.(e)
- S124. Ans.(b)
- S125. Ans.(c)

Solution (126-130):

Word	Code
------	------

RBI Office Attendant | Free Practice PDF | All Subjects | PDF-1 | Solutions

Culture	jo
Money	nk
Brain	cl
India	da
Hope	rs
Increase	ha

S126. Ans.(b)

S127. Ans.(a)

S128. Ans.(d)

S129. Ans.(b)

S130. Ans.(a)

Solution (131-135):

Word	Code
Smart	hx
Picture	xe
Test	zh
Work	da
Airport	dx
Standard	ha

S131. Ans.(b)

S132. Ans.(a)

S133. Ans.(c)

S134. Ans.(d)

S135. Ans.(b)

Direction (136-140):

Word	Code
Some	Cy
Policy	Om
Are	Ae
Fake	Ke
Election	gh/no
Right	no/gh
Vote	ea/ta
Team	ta/ea

S136. Ans.(c)

S137. Ans.(e)

S138. Ans.(e)

S139. Ans.(d)

S140. Ans.(a)

Solution (141-145):

S141. Ans.(d)

Sol. I: $Y \leq C$ (False)

II: $P > N$ (False)

S142. Ans.(b)

Sol. I: $B \geq M$ (False)

II: $B > M$ (True)

S143. Ans.(c)

Sol. I: $K > G$ (False)

II: $K \leq G$ (False)

S144. Ans.(b)

Sol. I: $R > Y$ (False)

II: $Q = I$ (True)

S145. Ans.(e)

Sol. I: $I < U$ (True)

II: $V \geq P$ (True)

Solution (6-10):

S146. Ans.(c)

Sol. I: $Y \leq R$ (False)

II: $Y > R$ (False)

S147. Ans.(b)

Sol. I: $P > G$ (False)

II: $P > T$ (True)

S148. Ans.(a)

Sol. I: $R > U$ (True)

II: $U \leq R$ (False)

S149. Ans.(e)

Sol. I: $Z > E$ (True)

II: $Z > O$ (True)

S150. Ans.(d)

Sol. I: $N > H$ (False)

II: $Y \geq M$ (False)

Solutions (11-15):

S151. Ans.(d)

Sol. I: $W \leq Y$ (False)

II: $P > G$ (False)

S152. Ans.(b)

Sol. I: $C = A$ (False)

II: $C > A$ (True)

S153. Ans.(c)

Sol. I: $D > B$ (False)

II: $D \leq B$ (False)

S154. Ans.(b)

Sol. I: $R > S$ (False)

II: $C \leq T$ (True)

S155. Ans.(e)

RBI Office Attendant | Free Practice PDF | All Subjects | PDF-1 | Solutions

Sol. I: $U > R$ (True)

II: $Z > R$ (True)

Sol. U1&, D8%

Solutions (16-20):

S177. Ans.(d)

S156. Ans.(d)

S178. Ans.(c)

Sol. I: $W < P$ (False)

II: $N > Y$ (False)

Sol. 1&A

S157. Ans.(b)

S179. Ans.(c)

Sol. I: $O = X$ (False)

II: $O > X$ (True)

Sol. 5 Y 5

S158. Ans.(b)

Sol. I: $I > R$ (False)

II: $L > M$ (True)

S180. Ans.(b)

S159. Ans.(e)

Sol. I: $E > X$ (True)

II: $M > W$ (True)

S181. Ans.(c)

Sol. Substitute 'guide' to with 'guides'.

S160. Ans.(c)

Sol. I: $P < A$ (False)

II: $P \geq A$ (False)

S182. Ans.(c)

Sol. Substitute 'does' with 'did'.

Solution (161-165):

S161. Ans.(d)

S183. Ans.(a)

S162. Ans.(b)

Sol. Substitute 'deplete' with 'depletion'.

S163. Ans.(c)

S164. Ans.(e)

S184. Ans.(a)

S165. Ans.(c)

Sol. Substitute 'which' with 'who'.

Solutions (166-170):

S166. Ans.(c)

S185. Ans.(b)

Sol. Substitute 'toreducing' with 'reduce'.

S167. Ans.(d)

Sol. H8I, Y2A, K5U

S186. Ans.(b)

Sol. Substitute 'suffering from' for 'suffering for'

S168. Ans.(d)

Sol. 3©R, 6#U, 1&Z

S187. Ans.(d)

Sol. Substitute plural 'premises' for 'premise'

S169. Ans.(b)

Sol. PW\$

S188. Ans.(d)

Sol. Delete 'one's'

S170. Ans.(a)

S189. Ans.(b)

Sol. Substitute 'various' for 'variety'

Solution (171-175):

S171. Ans.(e)

S190. Ans.(c)

S172. Ans.(e)

Sol. Substitute plural 'institutes' for 'institute'

S173. Ans.(c)

S174. Ans.(c)

S191. Ans.(a)

Sol. Remove 'are'. Its use is superfluous

S175. Ans.(a)

Solution (176-180):

S192. Ans.(d)

S176. Ans.(b)

RBI Office Attendant | Free Practice PDF | All Subjects | PDF-1 | Solutions

Sol. Use 'heavy' in place of 'heavily'. Here, an adjective is required.

S193. Ans.(e)

Sol. The sentence is correct.

S194. Ans.(b)

Sol. Remove 'in'. Its use is superfluous.

S195. Ans.(c)

Sol. Use 'depends' in place of 'is dependence'. Here, verb is required in Present Indefinite Tense.

S196. Ans.(a)

Sol. 'So' is replaced by 'such a'

S197. Ans.(a)

Sol. 'interesting' is replaced by 'interested'

S198. Ans.(b)

Sol. 'comprising' is replaced by 'comprises'

S199. Ans.(c)

Sol. 'of twenty percent' is replaced by 'than twenty percent'

S200. Ans.(d)

Sol. 'approximate' is replaced by 'approximately'

S201. Ans.(e)

Sol. The proper sequence of sentences to form a meaningful paragraph will be **EBACFD**.

S202. Ans.(d)

Sol. The proper sequence of sentences to form a meaningful paragraph will be **EBACFD**.

S203. Ans.(a)

Sol. The proper sequence of sentences to form a meaningful paragraph will be **EBACFD**.

S204. Ans.(b)

Sol. The proper sequence of sentences to form a meaningful paragraph will be **EBACFD**.

S205. Ans.(e)

Sol. The proper sequence of sentences to form a meaningful paragraph will be **EBACFD**.

S206. Ans.(b)

Sol. The proper sequence of sentences to form a meaningful paragraph will be **D F B A E C**

S207. Ans.(a)

Sol. The proper sequence of sentences to form a meaningful paragraph will be **D F B A E C**

S208. Ans.(c)

Sol. The proper sequence of sentences to form a meaningful paragraph will be **D F B A E C**

S209. Ans.(b)

Sol. The proper sequence of sentences to form a meaningful paragraph will be **D F B A E C**

S210. Ans.(e)

Sol. The proper sequence of sentences to form a meaningful paragraph will be **D F B A E C**

S211. Ans.(b)

Sol. The proper sequence of sentences to form a meaningful paragraph will be **CFDABE**.

S212. Ans.(e)

Sol. The proper sequence of sentences to form a meaningful paragraph will be **CFDABE**.

S213. Ans.(c)

Sol. The proper sequence of sentences to form a meaningful paragraph will be **CFDABE**.

S214. Ans.(e)

Sol. The proper sequence of sentences to form a meaningful paragraph will be **CFDABE**.

S215. Ans.(c)

Sol. The proper sequence of sentences to form a meaningful paragraph will be **CFDABE**.

S216. Ans.(d)

Sol. The proper sequence of sentences to form a meaningful paragraph will be **BDAEC**

S217. Ans.(a)

Sol. The proper sequence of sentences to form a meaningful paragraph will be **BDAEC**

S218. Ans.(e)

RBI Office Attendant | Free Practice PDF | All Subjects | PDF-1 | Solutions

Sol. The proper sequence of sentences to form a meaningful paragraph will be **BDAEC**

S219. Ans.(b)

Sol. The proper sequence of sentences to form a meaningful paragraph will be **BDAEC**

S220. Ans.(c)

Sol. The proper sequence of sentences to form a meaningful paragraph will be **BDAEC**

S221. Ans.(b)

Sol. 'meant' is the correct use.

S222. Ans.(e)

Sol. 'symbolise' is the correct use which means to represent something.

S223. Ans.(c)

Sol. 'squandering' is the correct use which means to waste (something, especially money or time) in a reckless and foolish manner.

S224. Ans.(a)

Sol. 'grim' is the correct use which means very serious or gloomy.

S225. Ans.(d)

Sol. 'eleventh' is an idiom which means at the last minute.

S226. Ans.(d)

Sol. Option (d) is the most suitable choice to be filled in the blank. Confliction can only happen in ethics.

Rest all of the options do not fit in the blank.

Prevalence means commonness, generality.

Defense means the action of defending from or resisting attack.

S227. Ans.(d)

Sol. The most suitable option to be filled in the blank is option (d) i.e. diversion. From a dull social life, diversion would mean the action of turning something aside from its course.

Obstruction means a thing that impedes or prevents passage or progress; an obstacle or blockage.

Alienation means the state or experience of being alienated, isolation.

Distraction means a thing that prevents someone from concentrating on something else.

Deliberation means long and careful consideration or discussion, contemplation.

S228. Ans.(b)

Sol. The most appropriate option to be filled in the blank is option (b). For leaving children, society would condemn a lady which means express complete disapproval of; censure.

Contrast means dissimilarity.

Exhaust means make someone feel very tired.

S229. Ans.(e)

Sol. The most suitable option to be filled in the blank is option (e) i.e. introspective which means self-examining. Tuning means telling something to someone.

Engaging means participating or becoming involved in.

Destructive means causing great and irreparable damage.

S230. Ans.(b)

Sol. Only option (b) fits appropriately in the blank. Rest all of the options are irrelevant.

Forthright means candid, outspoken.

Critically (adverb) means in a way that expresses disapproval.

Attacked means criticize or oppose fiercely and publicly.

S231. Ans.(c)

Sol. Endurable is the word that must come in both the blanks of the given statements. Since both the sentences are positive, they cannot take negative words like harsh and foul.

Endurable means bearable.

Tidy means arranged neatly and in order.

Harsh means unpleasantly rough or jarring to the senses.

Foul means wicked or immoral.

S232. Ans.(a)

Sol. Replace is the most appropriate word to be filled in both of the given blanks.

Replace will be used as it means taking the place of.

Refund is not apt as neither of the statement talks about the money.

Drain means deprive of strength or vitality.

Hamper means hinder or impede the movement or progress of. Both drain and hamper are contextually wrong to use.

S233. Ans.(b)

RBI Office Attendant | Free Practice PDF | All Subjects | PDF-1 | Solutions

Sol. Baffle is the most appropriate word to be filled in both the blanks of the statements.

Baffle means to confuse, perplex.

In both of the given statements confusion is referred that the black holes confuse scientists in statement 1. While in statement 2, the exam questions were made to confuse some person completely.

S234. Ans.(d)

Sol. Mystery is the most suitable word to be used in both of the blanks of the statements. Mystery means something that is difficult or impossible to understand or explain.

Gloss means try to conceal or disguise (something unfavorable) by treating it briefly or representing it misleadingly.

Repulsion means a feeling of intense distaste or disgust.

Account means a report or description of an event or experience.

S235. Ans.(b)

Sol. Option (b) is the most relevant answer in reference to both the statements. This is so because both the statements refer about the men which can be wise because a comparison has to be used in the sentences by referring to the weak and the wise and then a fool and wise.

Victim is someone who is tricked or duped.

Eminent means famous and respected within a particular sphere.

Servile means referring to slave.

Gentle means moderate in action, effect, or degree; not strong or violent.

S236. Ans.(d)

Sol. Bagged [bag, verb] = put (something) in a bag.

Among the given options, the options (a), (b), (c) and (e) are completely irrelevant to the context of the sentence.

The option (d) 'accompanied' is the correct answer.

S237. Ans.(a)

Sol. The options (b), (c), (d) and (e) are completely irrelevant.

What feeling a person gets when mosquito buzzes in someone's ears?

The option (a) is the most relevant word. Moreover, the option (a) is also relevant for the second sentence.

Hence, the correct answer is the option (a).

S238. Ans.(b)

Sol. What could be attributed to the higher usage of public transport in Chennai?

Among the given options, 'cheaper' travel on local buses is the most relevant option and is the correct answer.

The options (a), (c), (d) and (e) are completely irrelevant.

Hence, the correct answer is the option (b).

S239. Ans.(d)

Sol. Among the given options, only option (d) 'confirmed' is the most appropriate choice and the correct answer.

What could witnesses do to the victim's account in the court of law?

They could 'confirm' it.

What could the Senate do to the President's candidate for Secretary of Defense?

The senate could 'confirm' it.

The options (a), (b), (c) and (e) are completely irrelevant as per the context of the sentence.

S240. Ans.(e)

Sol. What, among the options, could be the concern of a mother for her small child?

The mother wouldn't desire to disappoint her small child. Similarly, 'the Prime Minister of Greece doesn't want to disappoint everyone by postponing the visit to India' is a sensible, contextually meaningful and grammatically correct sentence.

Among the given options, the option (e) 'disappoint' is the most relevant word to fill the blank.

Hence, the correct answer is the option (e).

S241. Ans.(d)

Sol. The 'National Organ Donation Day' is observed in India every year on 27 November, since past 10 years.

S242. Ans.(e)

Sol. The International Day of Solidarity with the Palestinian People is a UN-organized day held every year on November 29.

S243. Ans.(b)

Sol. India and Finland signed an MoU for developing cooperation in the field of Environment protection and biodiversity conservation.

RBI Office Attendant | Free Practice PDF | All Subjects | PDF-1 | Solutions

S244. Ans.(c)

Sol. The first coal-based power plant of Arab Gulf country is being developed in Saih Shuaib, Dubai, United Arab Emirates.

S245. Ans.(a)

Sol. 2020 marks the 11th National Organ Donation Day.

S246. Ans.(e)

Sol. Prime Minister Shri Narendra Modi embarked on a three-city visit on 28 November 2020, to personally review the COVID-19 vaccine development and manufacturing process at facilities in these cities. Facilities visited by PM Modi are: Zydus Biotech Park in Ahmedabad, Bharat Biotech in Hyderabad and Serum Institute of India in Pune

S247. Ans.(d)

Sol. The United Nation recognised Day of Remembrance for all Victims of Chemical Warfare is held every year on since 2005.

S248. Ans.(b)

Sol. The Insurance Regulatory and Development Authority of India (IRDAI) has given its in-principle approval for the merger of Bharti AXA General Insurance with ICICI Lombard.

S249. Ans.(c)

Sol. British character actor David Prowse, best known for playing 'Darth Vader' in the original Star Wars trilogy, passed away.

S250. Ans.(a)

Sol. The UBS has projected India's real GDP to contract 10.5% in FY21, in its Global Economics & Markets Outlook 2021-2022 report.

S251. Ans.(b)

Sol. Private lender YES Bank launched an 'SMS Pay' functionality on POS terminals, which would allow merchants to accept contactless and remote payments from their customers.

S252. Ans.(e)

Sol. Prime Minister Shri Narendra Modi chaired the 33rd PRAGATI meeting on 25 November 2020 to review multiple projects, grievances and programmes. PRAGATI stands for Pro-Active Governance and Timely Implementation.

S253. Ans.(c)

Sol. Indian cricket team skipper Virat Kohli scripted another record in the game. He broke Sachin Tendulkar's record and became the quickest batsman to complete 22,000 runs.

S254. Ans.(e)

Sol. The Union Minister of Agriculture and Farmers' Welfare, Narendra Singh Tomar virtually inaugurated Honey Farmer Producer Organisation (FPO) Programme in five states, for producing honey.

S255. Ans.(d)

Sol. For the fiscal 2021-22 (FY22) UBS expect India's real GDP growth to rebound to +10% in FY22.

S256. Ans.(d)

Sol. The Union Minister of Earth Sciences, Science & Technology, Dr. Harsh Vardhan virtually inaugurated the web-based application "Digital Ocean".

S257. Ans.(c)

Sol. Arya Rajendran, the 21-year-old college student, has been elected the new mayor of Thiruvananthapuram Corporation, of Kerala.

S258. Ans.(e)

Sol. The Union Health Minister Dr Harsh Vardhan launched India's first indigenously developed vaccine against pneumonia on 28 December 2020. The Pneumococcal Conjugate Vaccine (PCV) named 'Pneumosil' has been developed by Pune-based Serum Institute of India (SII) in collaboration with the Bill and Melinda Gates Foundation and PATH.

S259. Ans.(d)

Sol. AU Small Finance Bank headquartered at Jaipur partnered with ICICI Prudential Life to offer life insurance solutions.

S260. Ans.(c)

RBI Office Attendant | Free Practice PDF | All Subjects | PDF-1 | Solutions

Sol. The Dr. Narendra Dabholkar Memorial Award for this year has been conferred upon Dravidar Kazhagam president K. Veeramani.

S261. Ans.(b)

Sol. The Chief Minister Secretariat, the Disaster Management Department besides the National Informatics Centre (NIC) of the Bihar state have jointly been chosen as winners in the "pandemic category" Digital India Awards 2020, instituted by the central government, this year for innovative steps in e-governance.

S262. Ans.(c)

Sol. India's first hot air balloon wildlife safari was launched at Bandhavgarh Tiger Reserve in Madhya Pradesh by MP forest minister Vijay Shah in line with the vision of Buffer Mein Safar.

S263. Ans.(a)

Sol. Late Justice Rajindar Sachar's Autobiography: 'In Pursuit of Justice'. The family of Late Justice Rajindar Sachar in association with The Indian Society of International Law and The Indian Law Institute is organizing the book launch "In Pursuit Of Justice: An Autobiography". Sachar committee appointed in 2005 to study the conditions of Muslims in India.

S264. Ans.(b)

Sol. Senior scientist Hemant Kumar Pandey has been honoured with DRDO's "Scientist of the Year Award" for his contribution in developing several herbal medicines, including the popular drug Lukoskin meant for the treatment of leucoderma.

S265. Ans.(d)

Sol. ICICI Bank has announced that it is collaborating with Google to issue FASTag. It has become the first bank to join hands with Google Pay for the issuance of FASTag.

S266. Ans.(b)

Sol. Former Indian captain and wicket-keeper batsman Mahendra Singh Dhoni has been named as the captain of the ICC ODI Team of the Decade. He has also been named the skipper of the ICC T20I Team of the Decade.

S267. Ans.(a)

Sol. The Myanmar Navy has officially inducted the submarine INS Sindhuvir, which was handed over by the Indian Navy to the country in October 2020. INS Sindhuvir was commissioned on 25th December 2020,

which marked the 73rd anniversary of the Myanmar Navy.

S268. Ans.(c)

Sol. Indian wrestler Anshu Malik has become the first wrestler of the country to finish on the podium position at the Individual Wrestling World Cup in Belgrade, Serbia.

S269. Ans.(b)

Sol. Former professional wrestler Jon Huber, who was popularly known by his ring name 'Luke Harper' in the WWE has passed away. Jon Huber was known by his ring name Brodie Lee in the All Elite Wrestling (AEW).

S270. Ans.(e)

Sol. The Badminton World Federation (BWF) has imposed a 5-year ban on Russian shuttler Nikita Khakimov for charges of "betting, wagering and irregular match results.

S271. Ans.(d)

Sol. Virat Kohli has been named the captain of the ICC Test Team of the Decade.

S272. Ans.(c)

Sol. ICC Spirit of Cricket Award of the Decade goes to MS Dhoni.

S273. Ans.(a)

Sol. Prime Minister Shri Narendra Modi inaugurated India's first-ever fully-automated driverless train service on 28 December 2020, on the Magenta Line of the Delhi Metro.

S274. Ans.(d)

Sol. Prime Minister Shri Narendra Modi flagged off the 100th 'Kisan Rail' on 28th December 2020, from Sangola in Maharashtra to Shalimar in West Bengal via video-conferencing.

S275. Ans.(a)

Sol. Union Minister of state (I/C) for AYUSH and Minister of State for Defence Shripad Naik released a Konkani book titled "Sutranivednachi sutra- ek anav". The book has been written by Dr Roopa Chari, a well-known personality in the field of Compering in Goa.

S276. Ans.(c)

Sol. Padma Shri awardee dance historian and critic Sunil Kothari has passed away after suffering cardiac arrest.

RBI Office Attendant | Free Practice PDF | All Subjects | PDF-1 | Solutions

S277. Ans.(b)

Sol. The Indian Navy and Vietnamese Navy undertook the naval passage exercise PASSEX in the South China Sea.

S278. Ans.(a)

Sol. Indian Space startup, Skyroot Aerospace has successfully test fired a solid propulsion rocket engine, named Kalam-5. With this, it has become the first private company of India to successfully design, develop and test a full solid-fueled rocket stage.

S279. Ans.(d)

Sol. In women's cricketers Australia's Ellyse Perry clinched the award in all three categories, ICC Women's Player of the Decade, ODI Player of the Decade and T20I Player of the Decade award.

S280. Ans.(e)

Sol. Sir Garfield Sobers Award for ICC Male Cricketer of the Decade goes to Virat Kohli.

S281. Ans.(a)

Sol. Every year, on 1 December, the world commemorates World AIDS Day. The day provides an opportunity for people worldwide to unite in the fight against HIV, to show support for people living with HIV and to commemorate those who have died from an AIDS-related illness.

S282. Ans.(c)

Sol. Senegal's professional footballer, Papa Bouba Diop, who helped the country win the FIFA World Cup match in 2002, has passed away.

S283. Ans.(b)

Sol. Lewis Hamilton (Mercedes-Great Britain) has won the 2020 Bahrain Grand Prix at Bahrain International Circuit, Bahrain.

S284. Ans.(a)

Sol. Lok Sabha Speaker Om Birla has appointed senior IAS officer Utpal Kumar Singh as Secretary-General of the Lok Sabha and Lok Sabha Secretariat.

S285. Ans.(c)

Sol. The Union Minister of Railways, Piyush Goyal has inaugurated newly electrified Dhigawara-Bandikui

section of North Western Railway (NWR) in the state of Rajasthan.

S286. Ans.(d)

Sol. The Government of India has appointed IAS officer Varsha Joshi as the new Chairperson of National Dairy Development Board (NDDB).

S287. Ans.(e)

Sol. Uttarakhand Chief Minister Trivendra Singh Rawat has inaugurated the Suryadhar lake at Doiwala, Dehradun.

S288. Ans.(c)

Sol. This year the theme of World AIDS Day is "Global solidarity, shared responsibility".

S289. Ans.(b)

Sol. BSF has been termed as the First Line of Defence of Indian Territories.

S290. Ans.(d)

Sol. The Border Security Force (BSF), is observing its 56th Raising Day on 01 December 2020.